

RIGHT 1

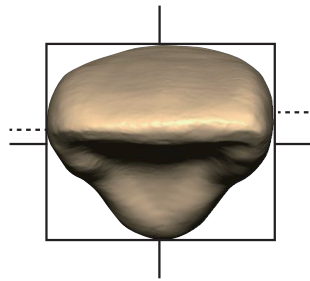

RIGHT 2

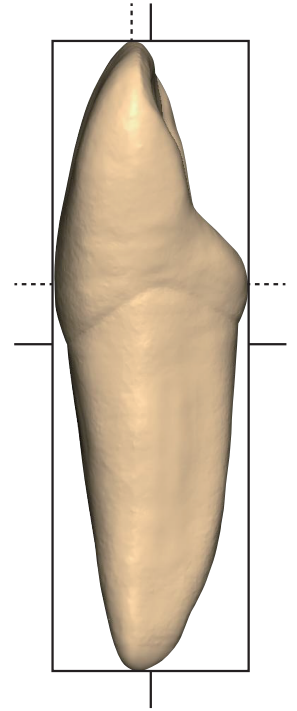
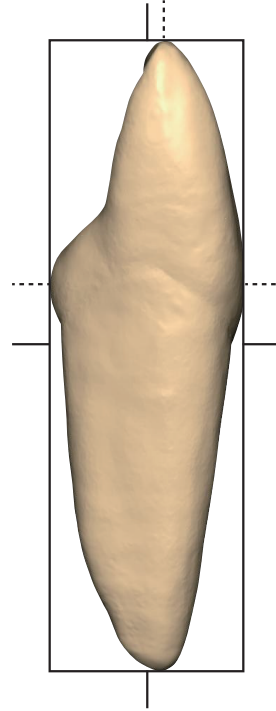
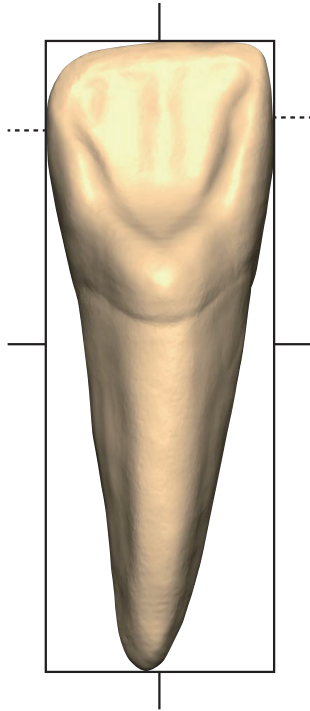
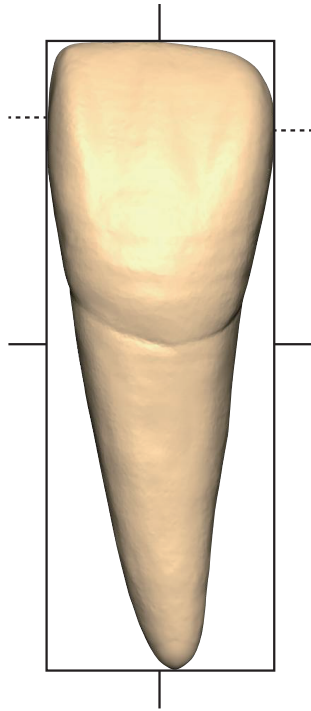
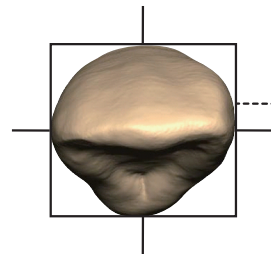
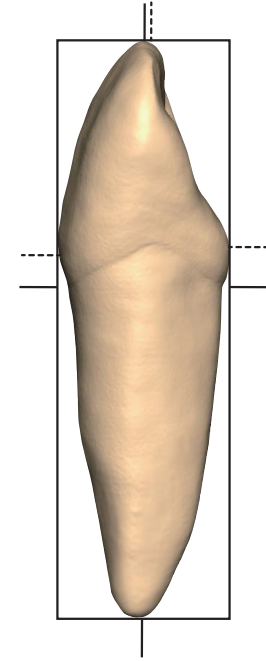
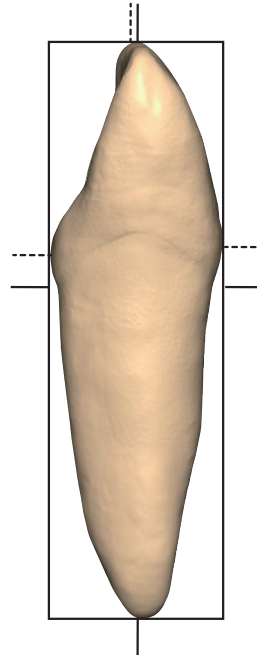
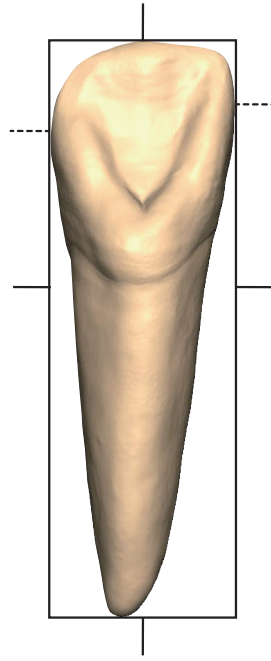
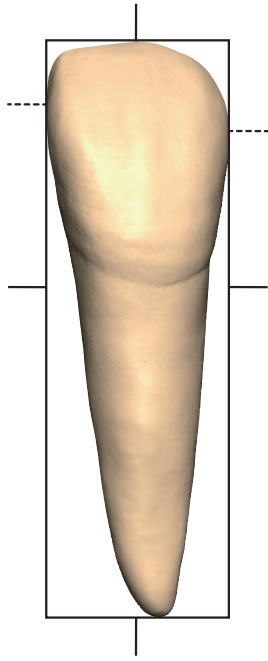

RIGHT 3

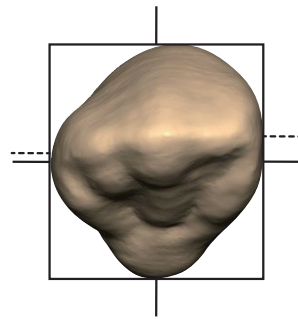
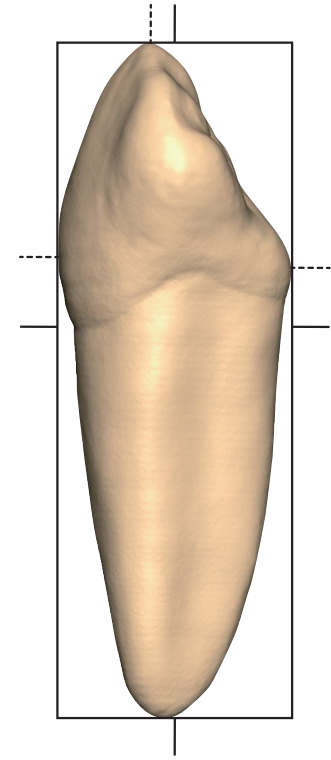
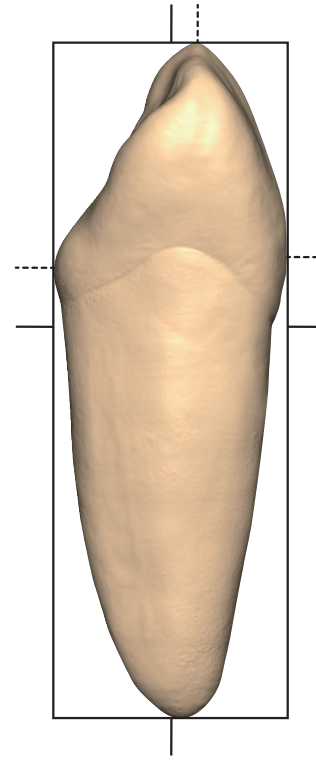
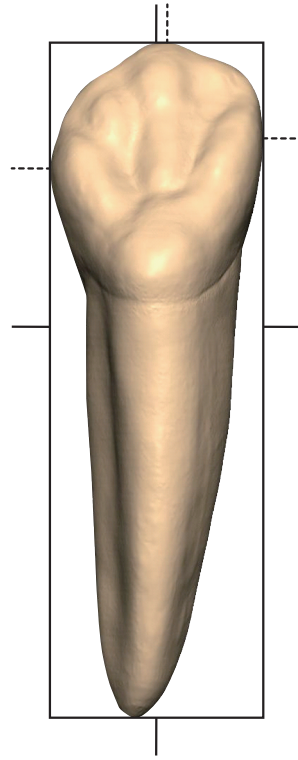
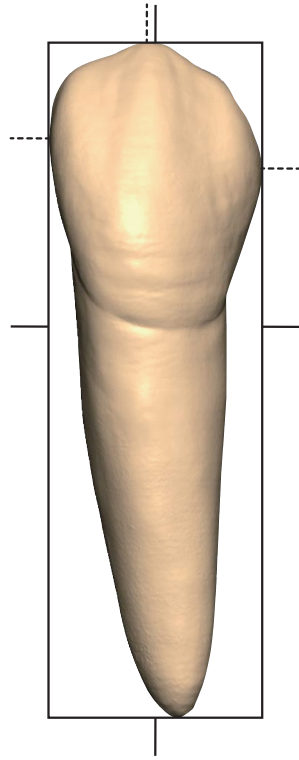

RIGHT 4

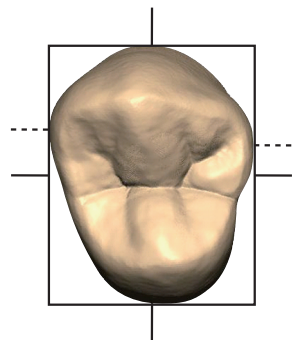
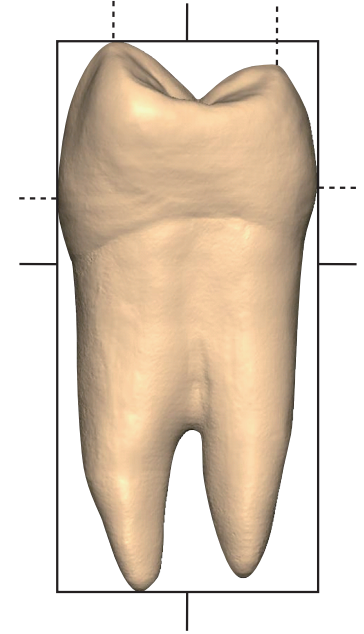
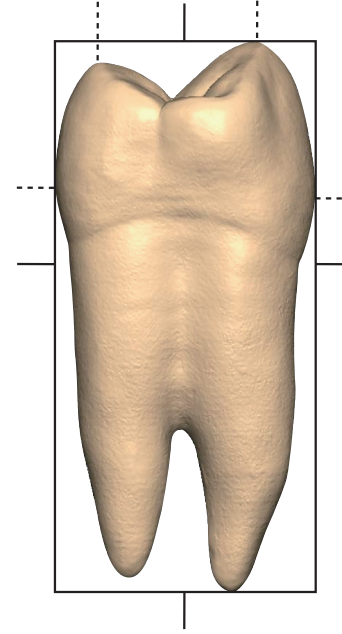
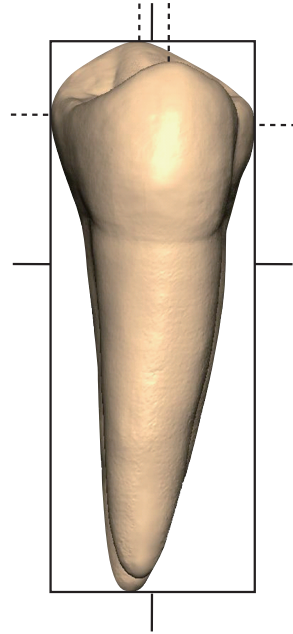
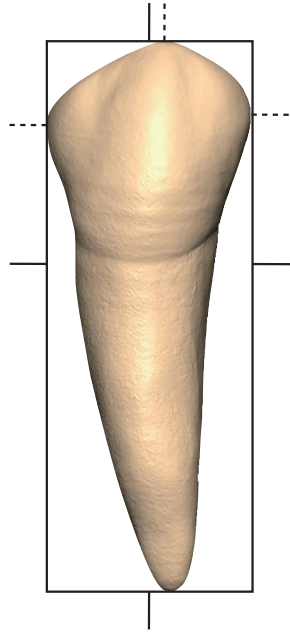

RIGHT 5

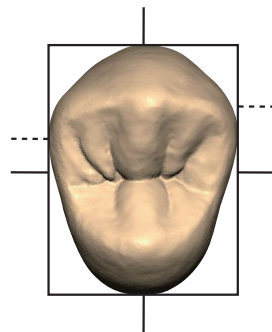
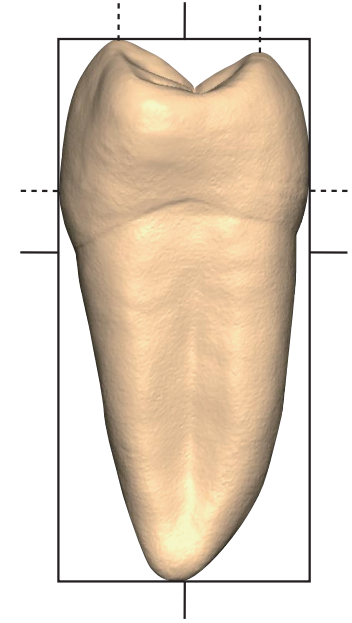
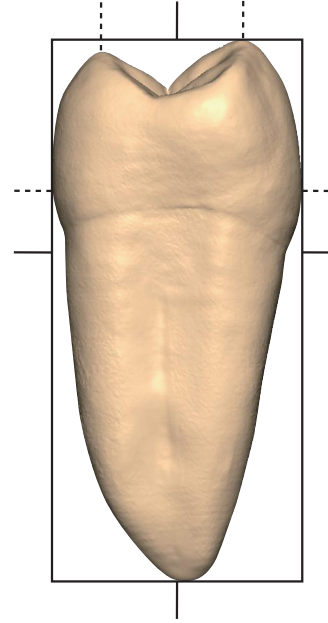
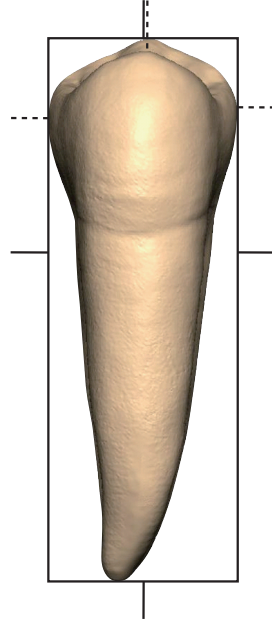
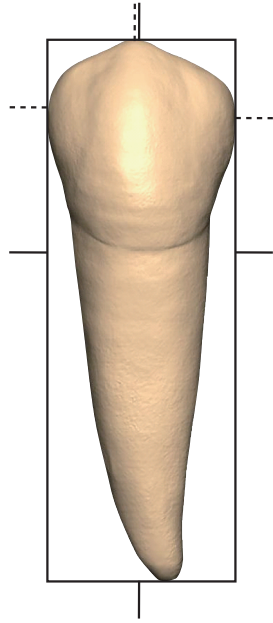

RIGHT 6

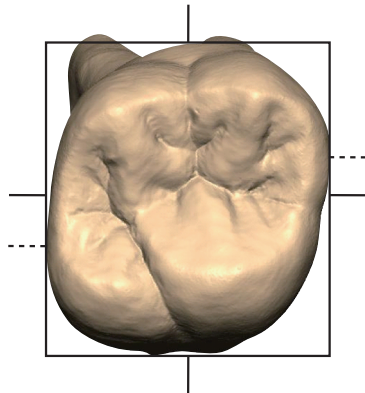
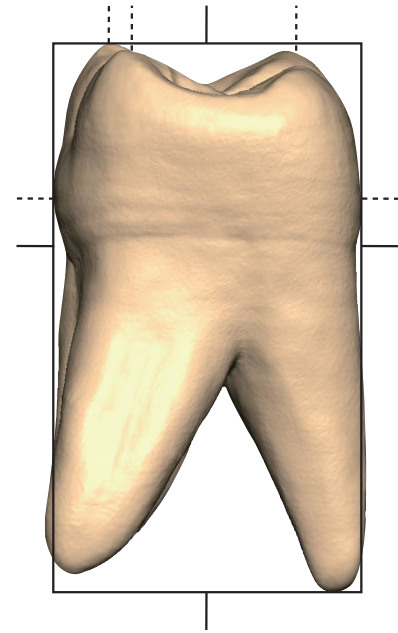
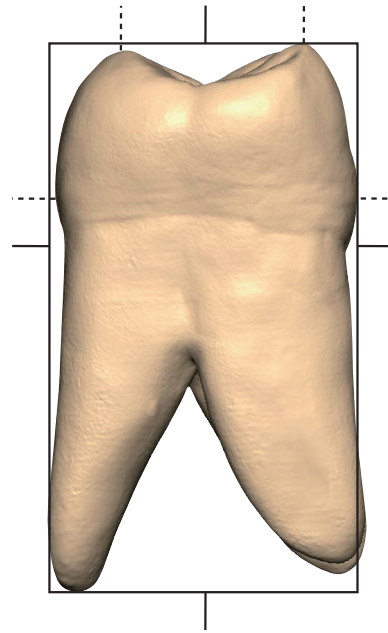
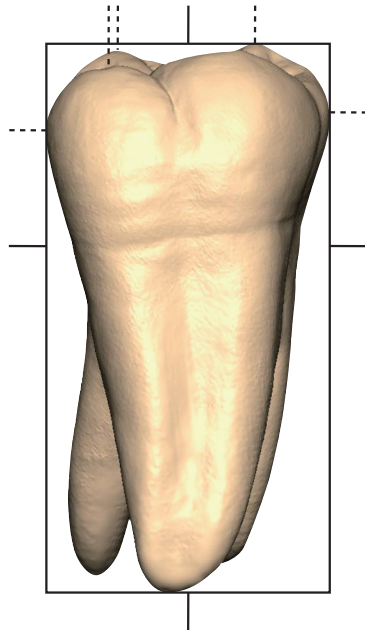
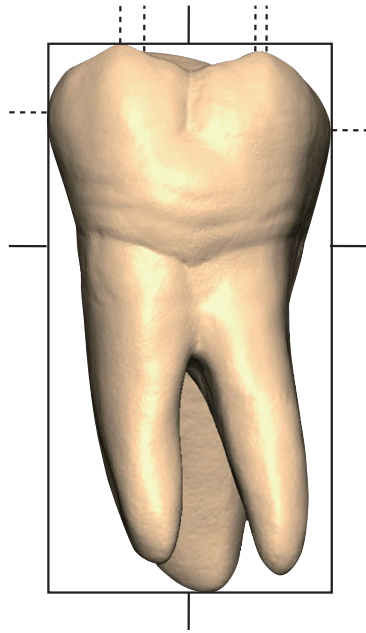

RIGHT 7

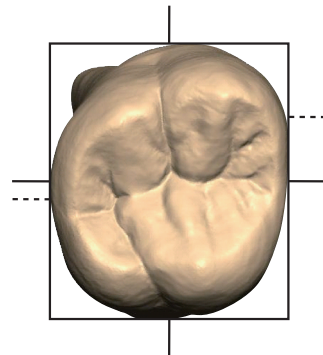
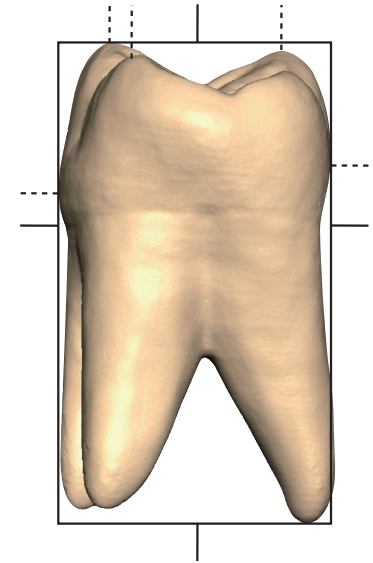
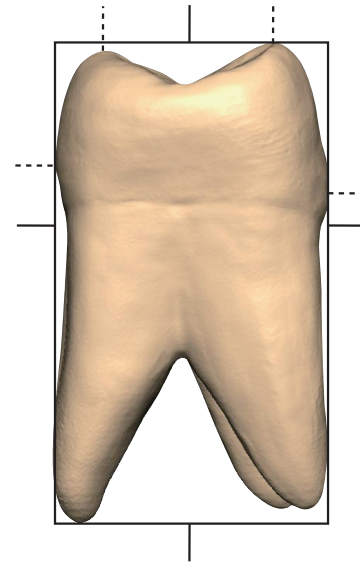
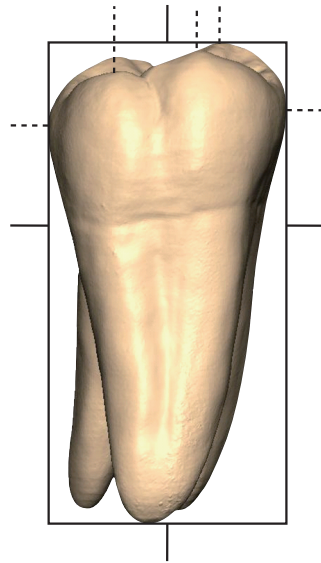
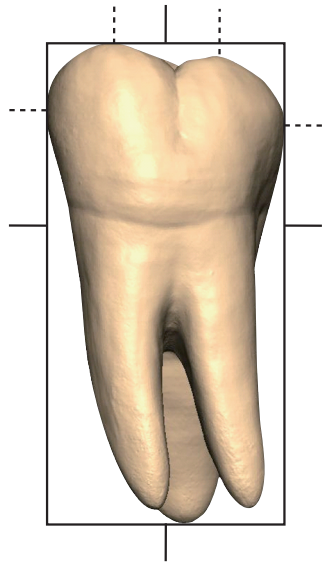

RIGHT 1

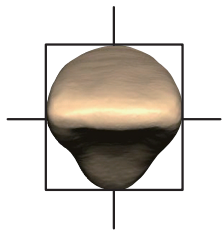
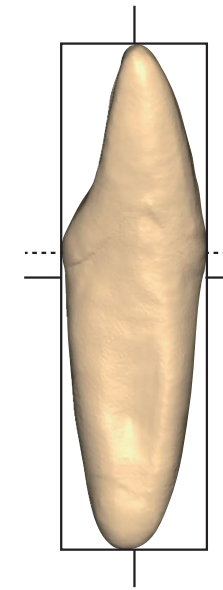
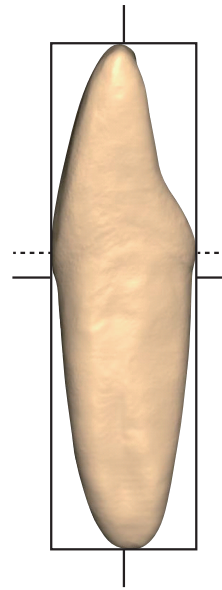
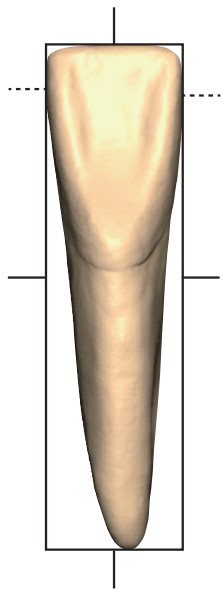
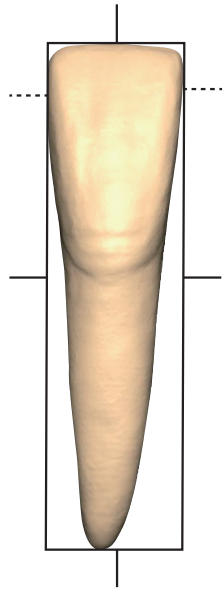

RIGHT 2

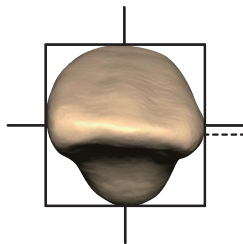
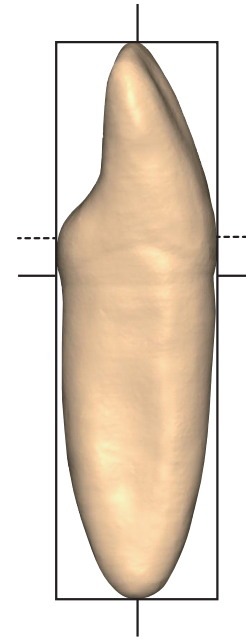
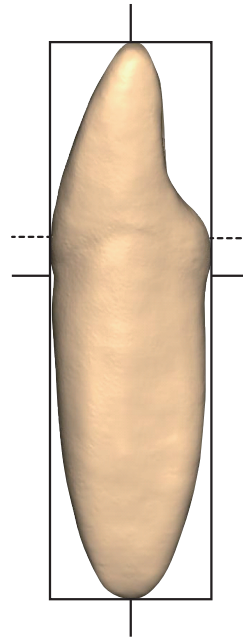
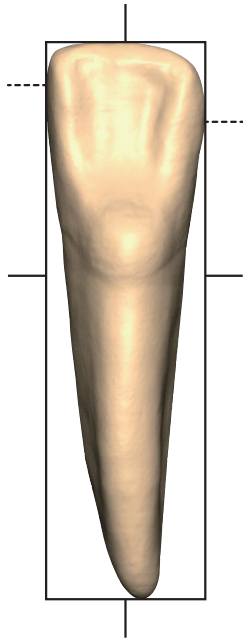
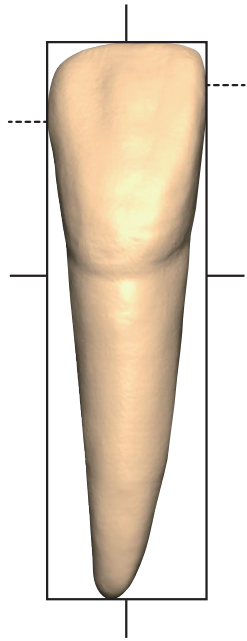

RIGHT 3

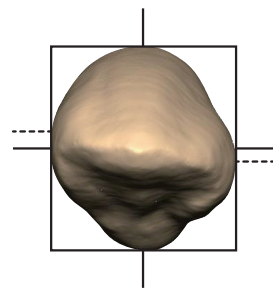
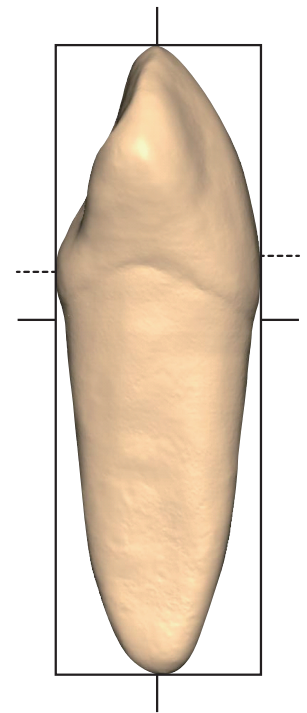
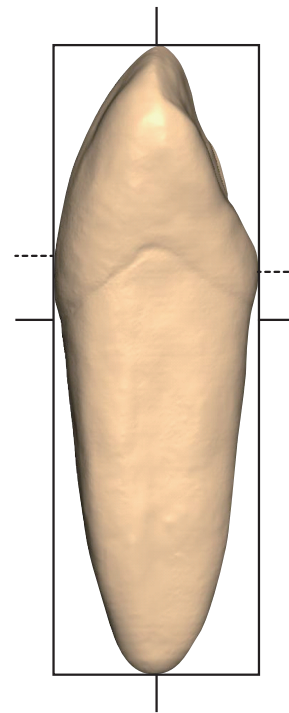
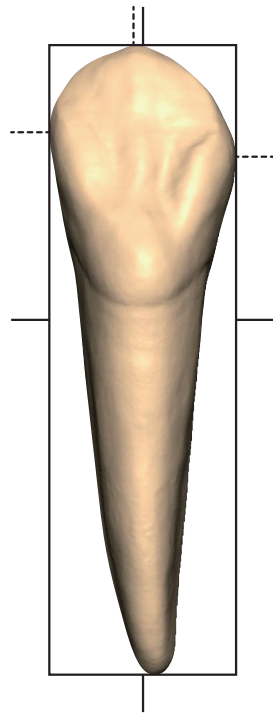
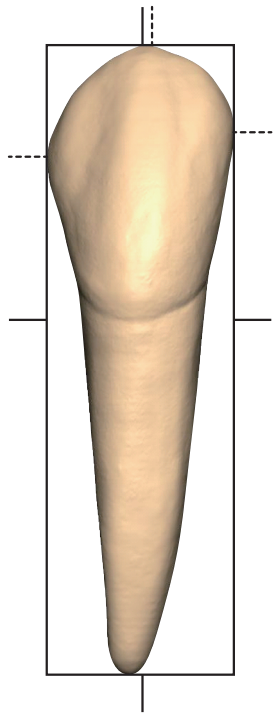

RIGHT 4

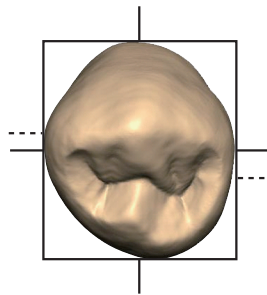
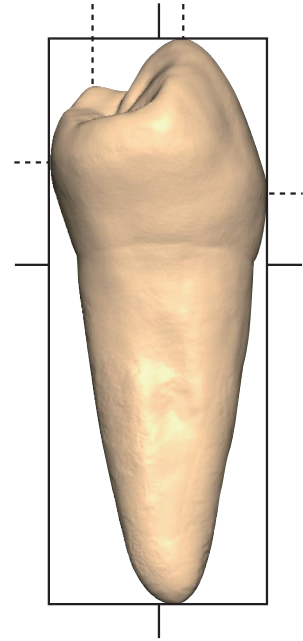
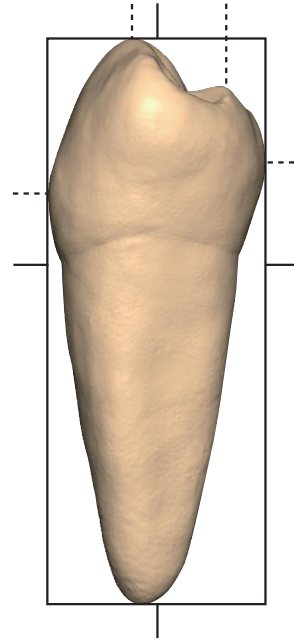
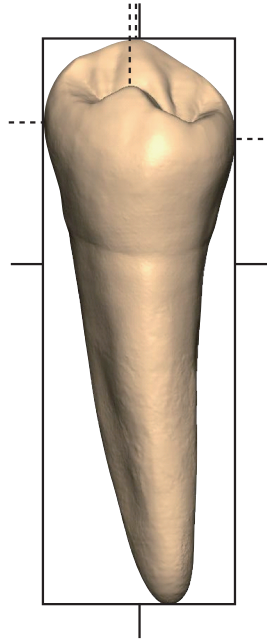
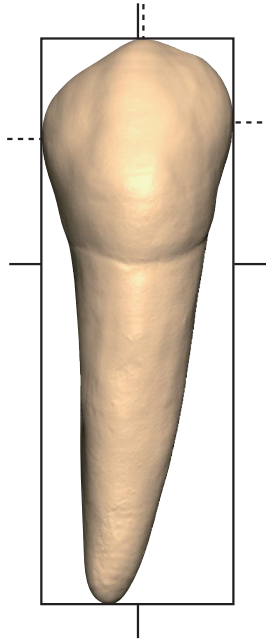

RIGHT 5

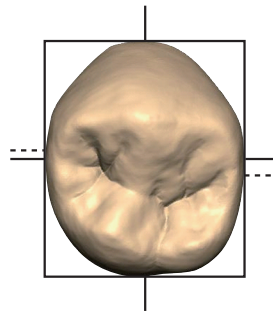
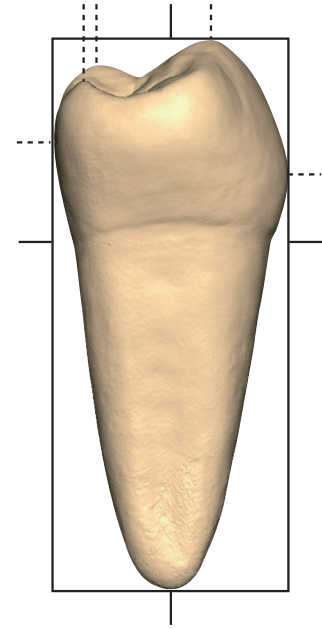
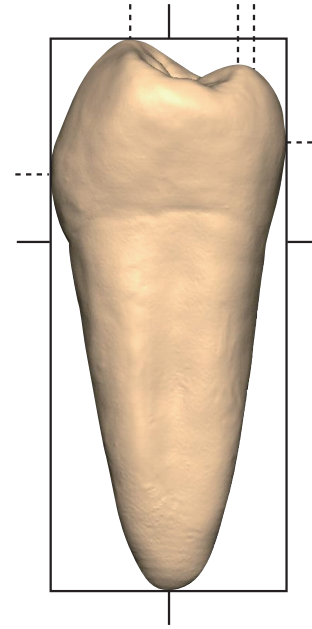
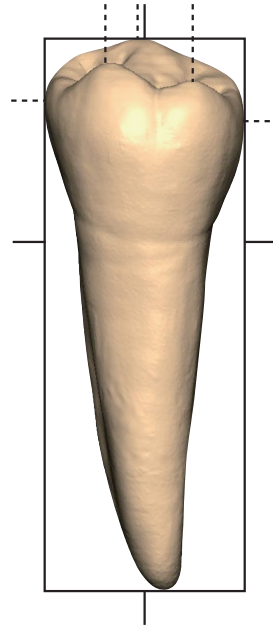
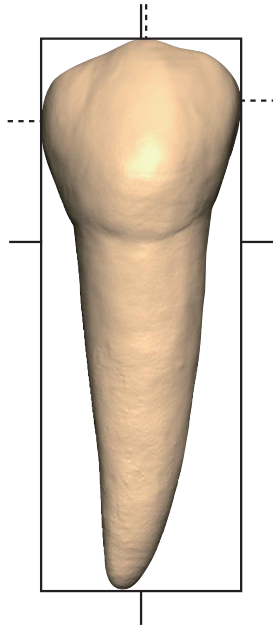

RIGHT $\overline{6}$

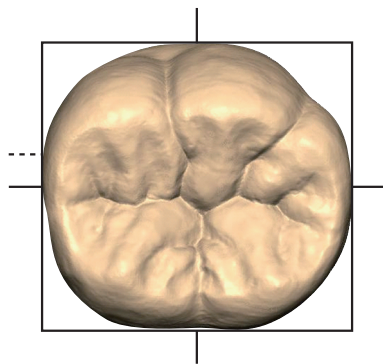
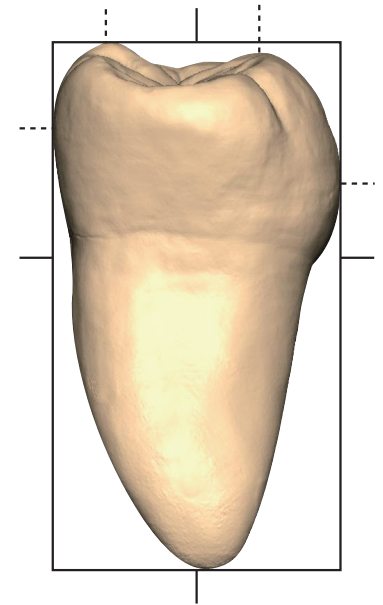
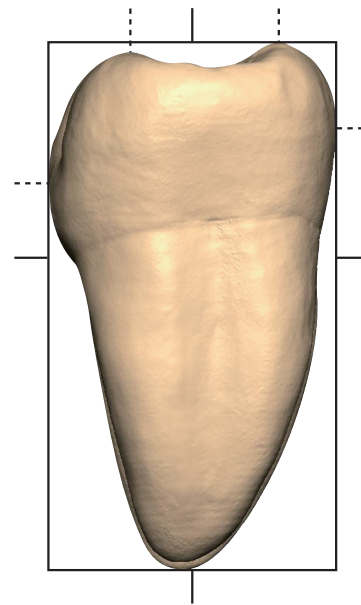
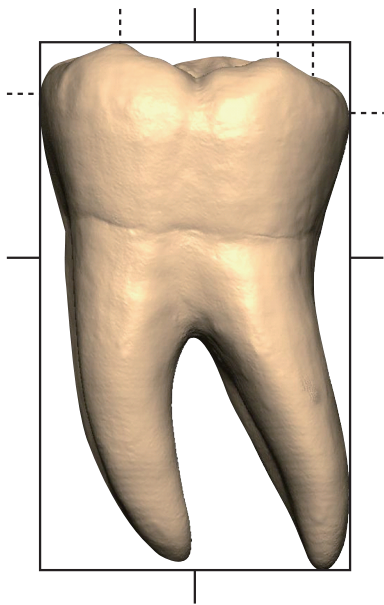
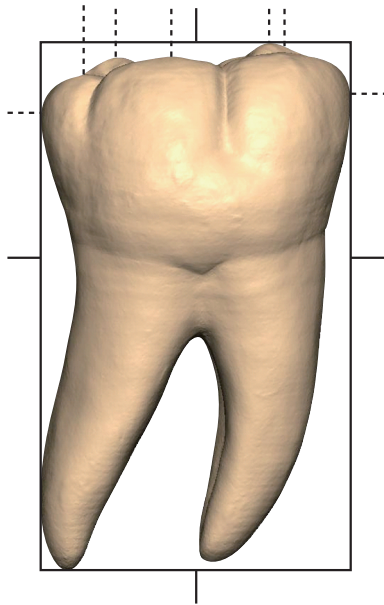

RIGHT 7

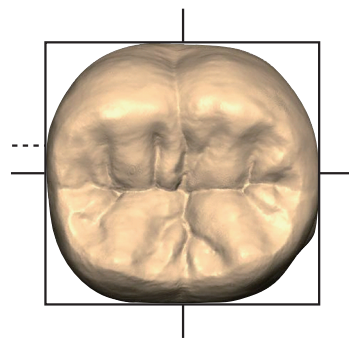
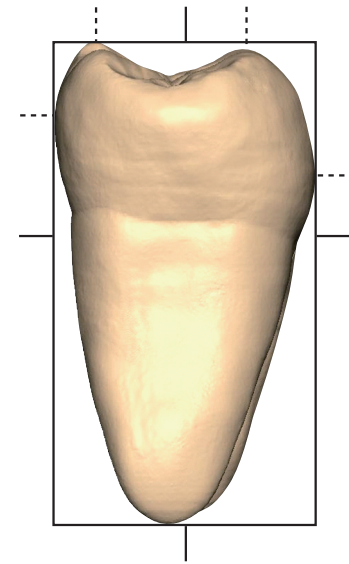
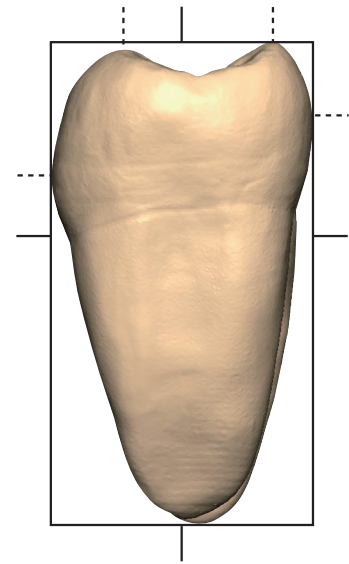
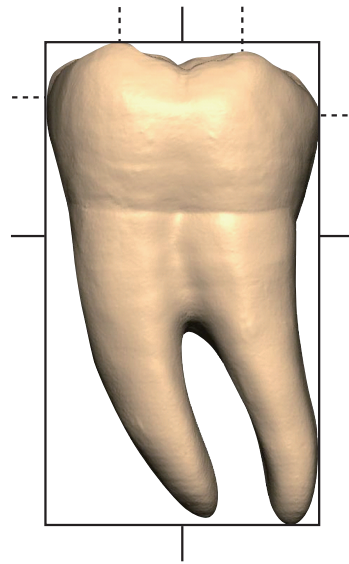
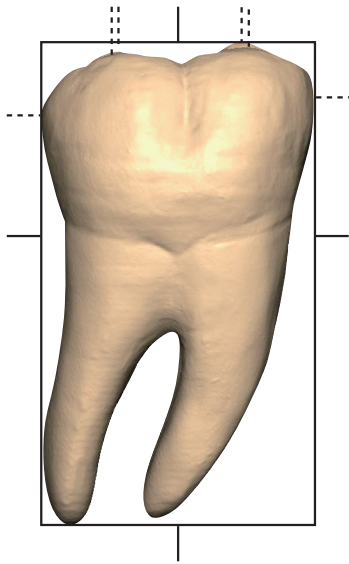

RIGHT 1

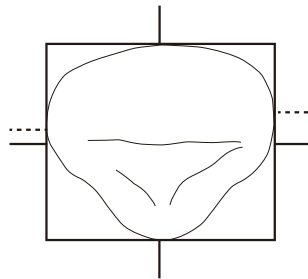
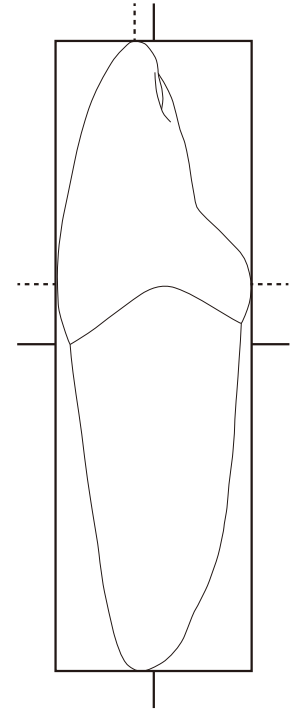
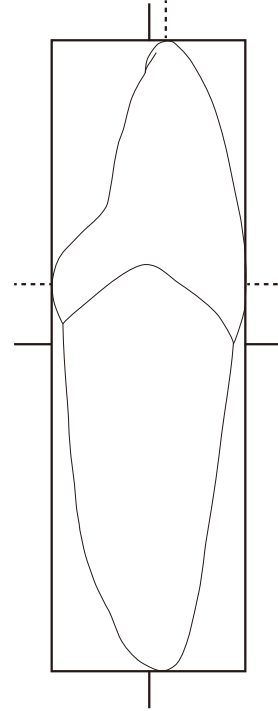
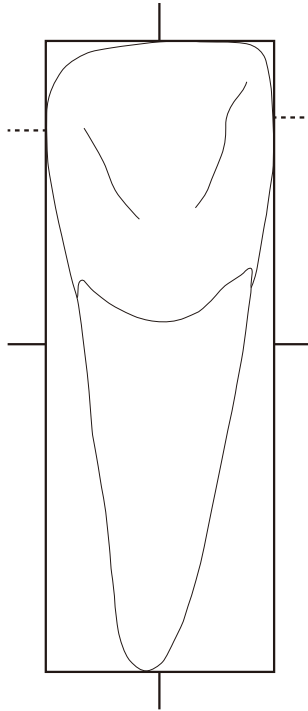
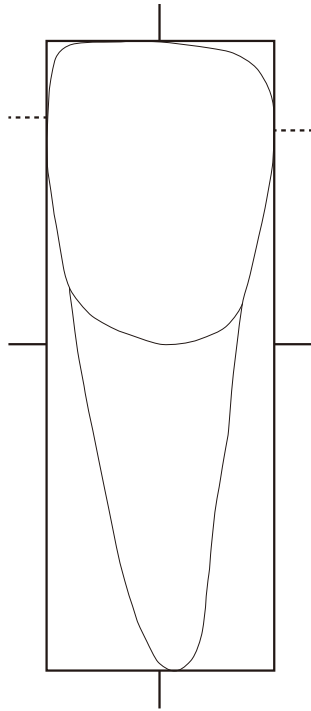

RIGHT 2

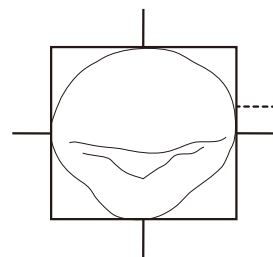
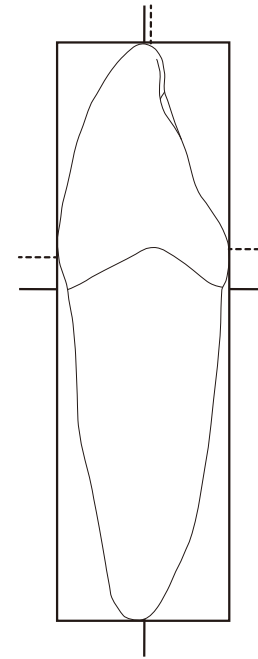
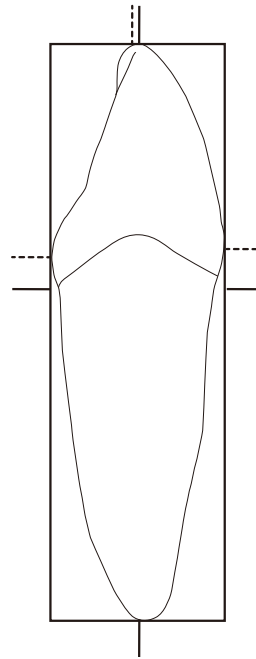
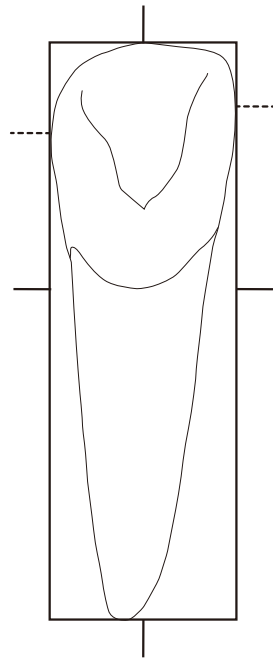
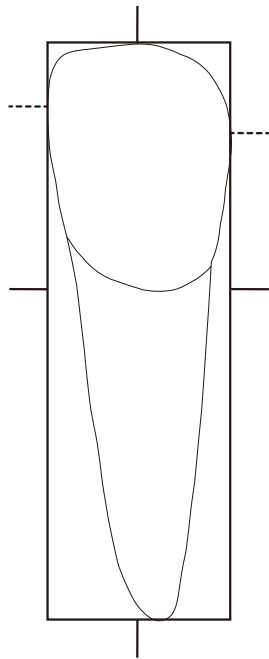

RIGHT 3

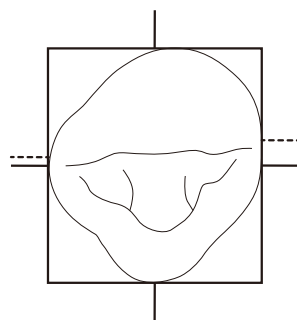
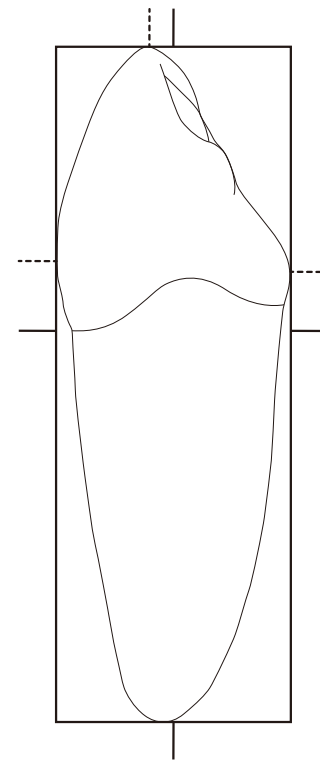
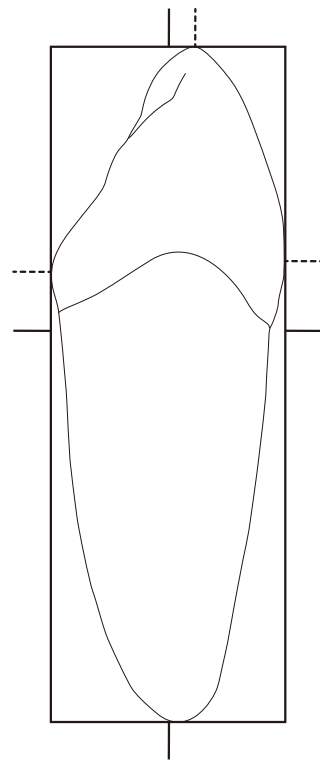
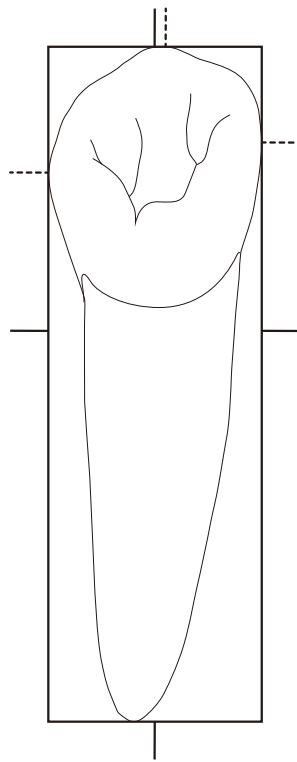
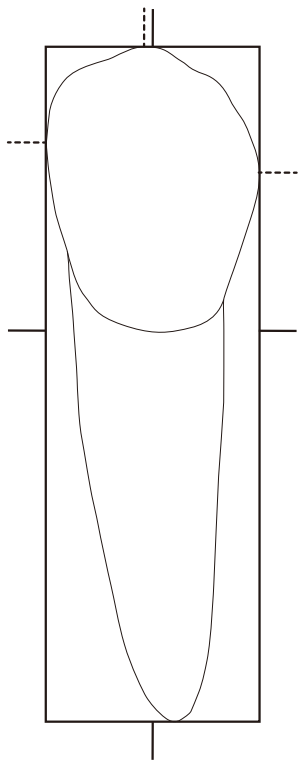

RIGHT 4

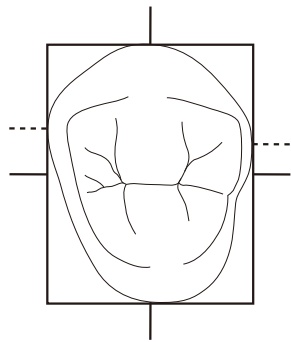
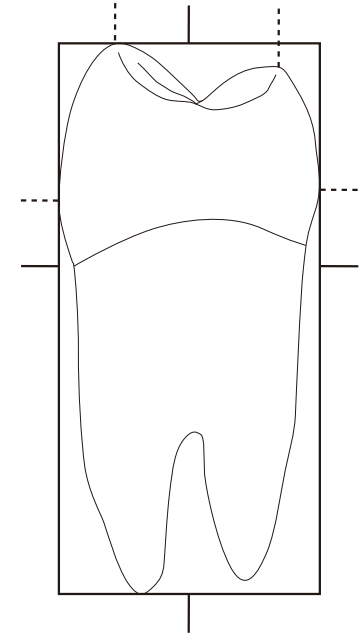
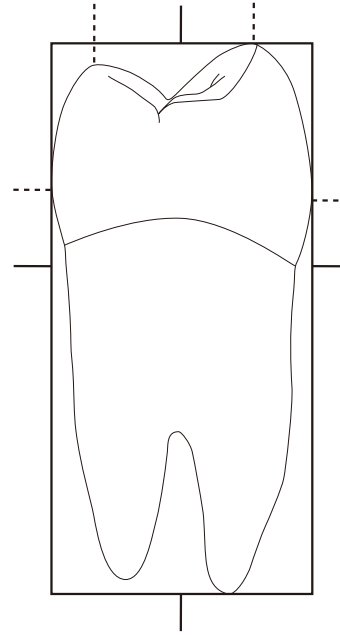
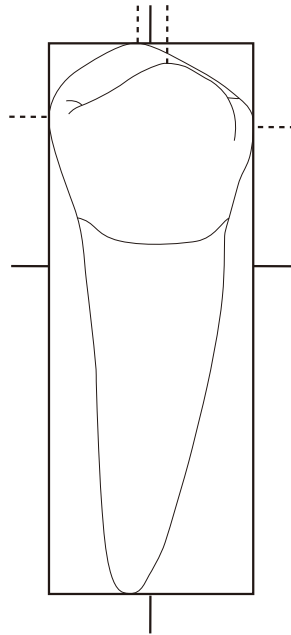
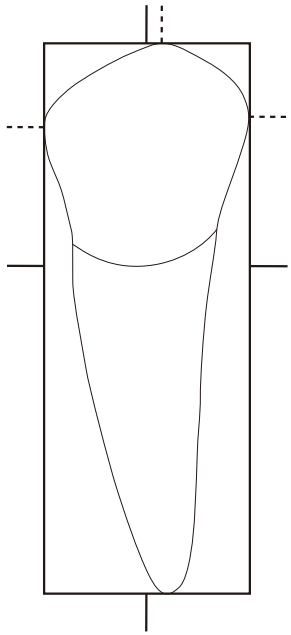

RIGHT 5

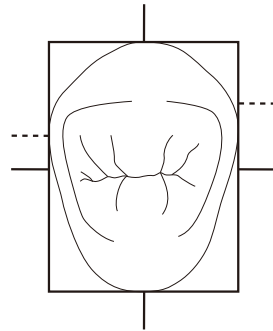
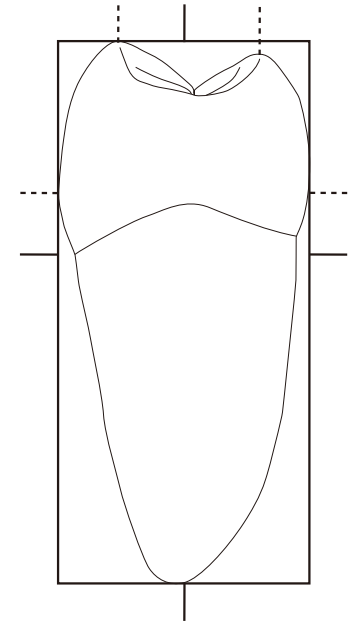
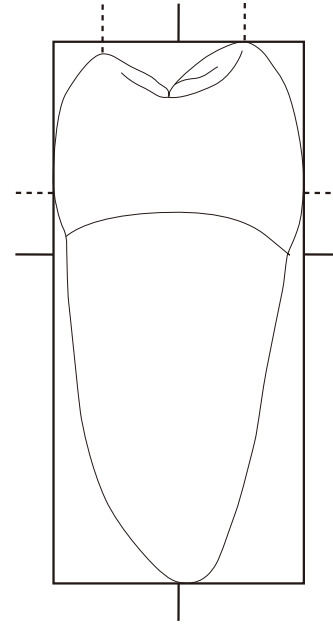
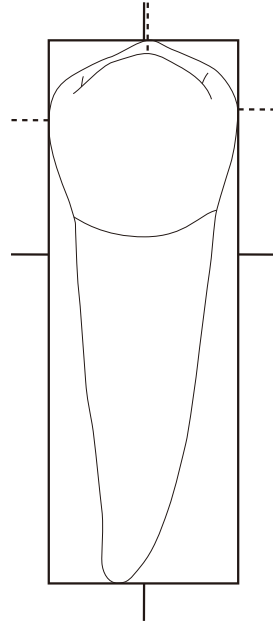
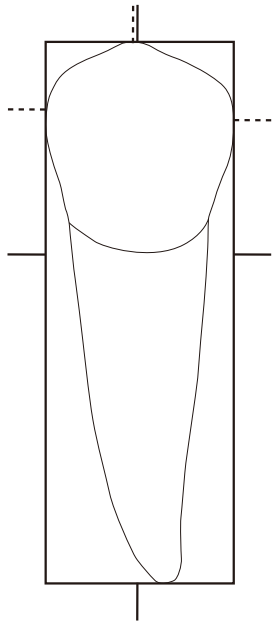

RIGHT 6

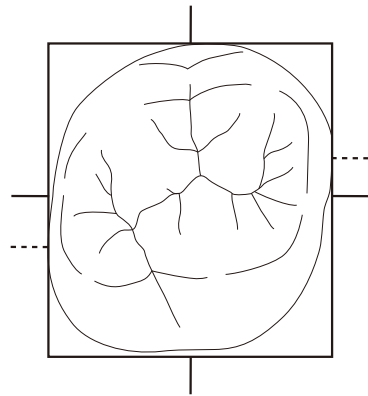
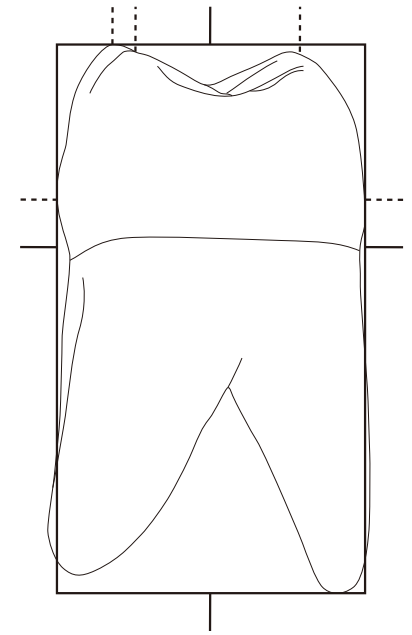
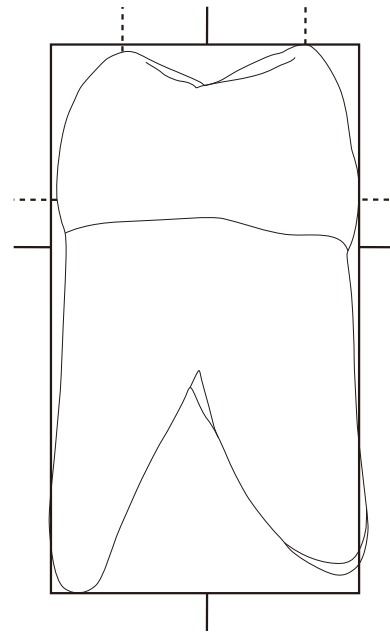
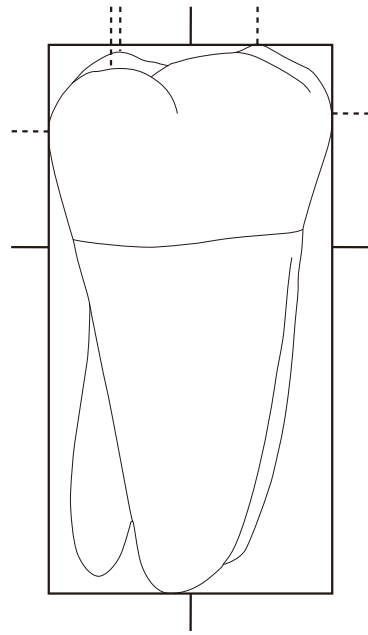
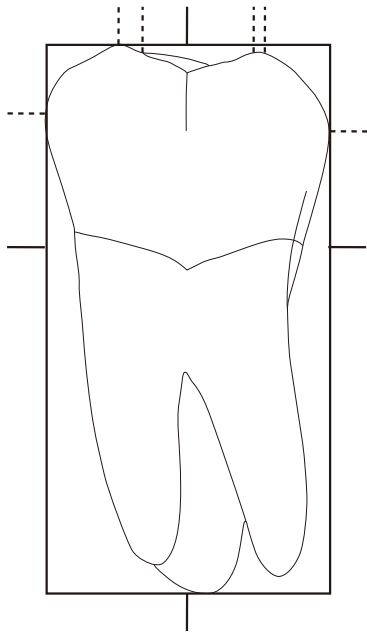

RIGHT 7

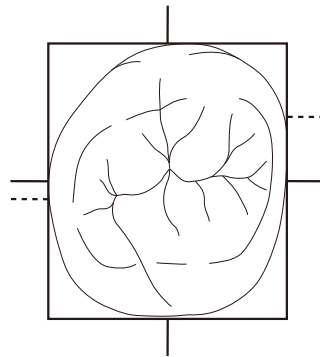
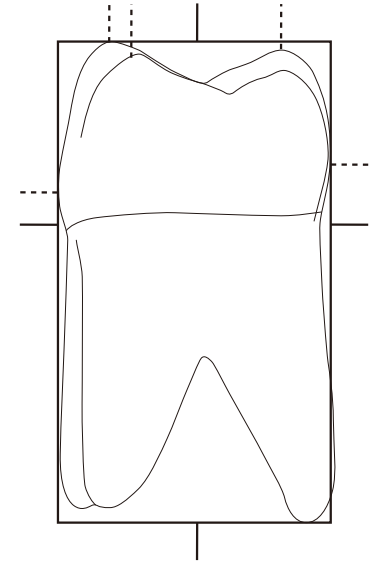
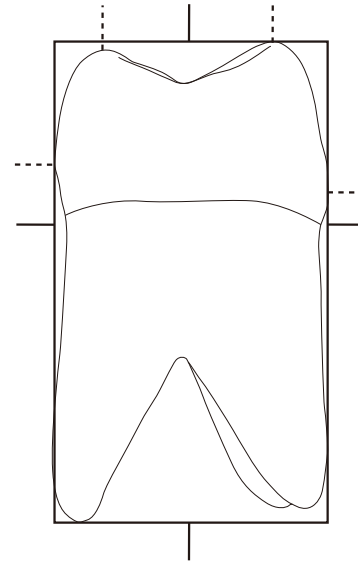
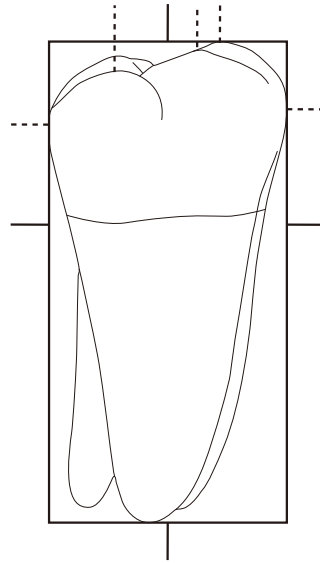
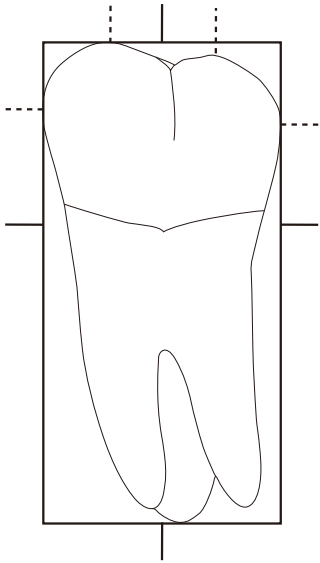

RIGHT 1

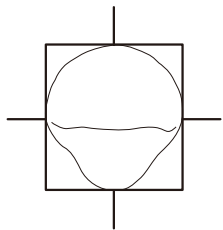
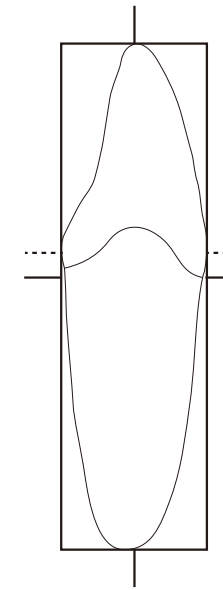
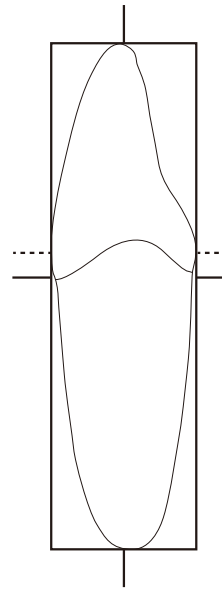
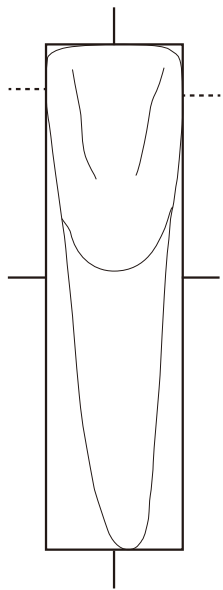
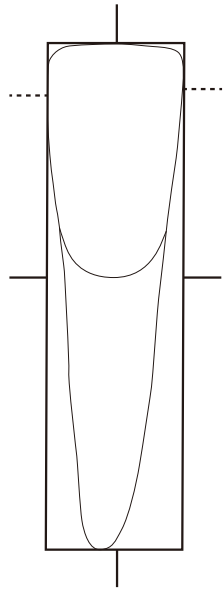

RIGHT 2

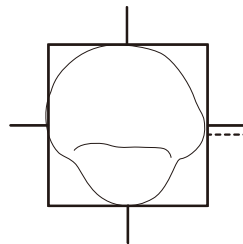
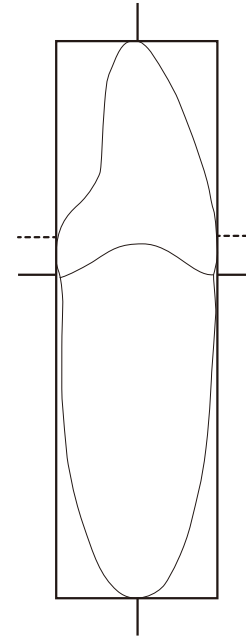
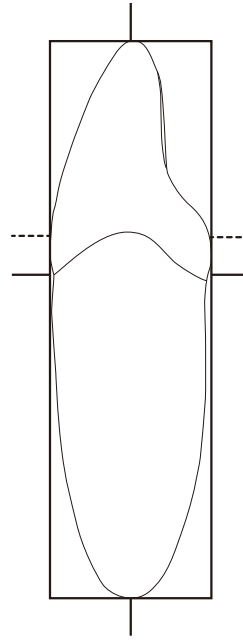
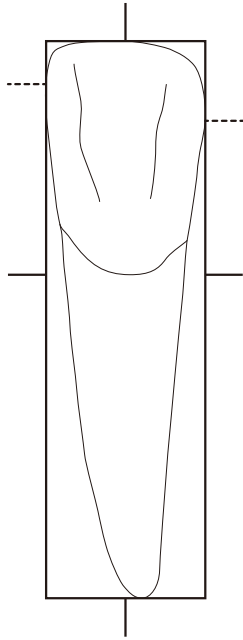
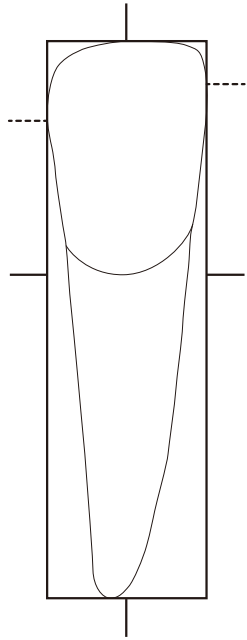

RIGHT 3

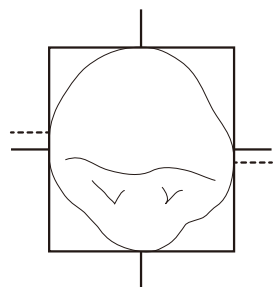
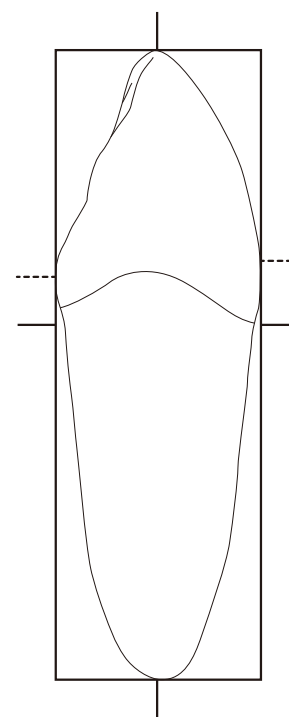
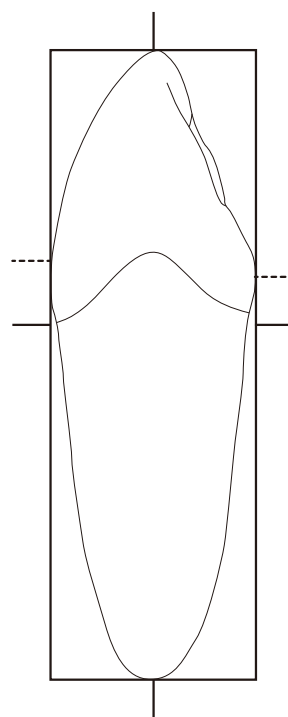
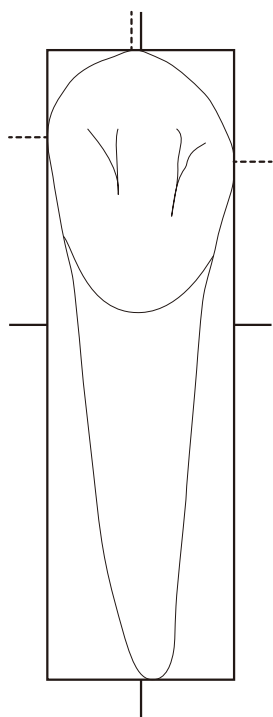
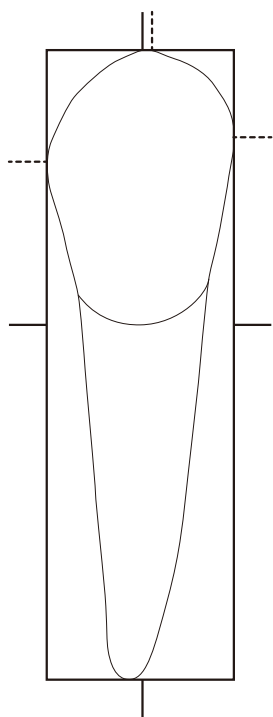

RIGHT 4

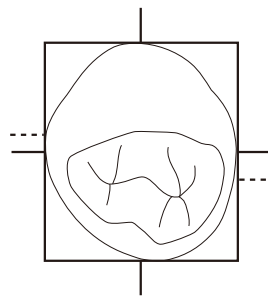
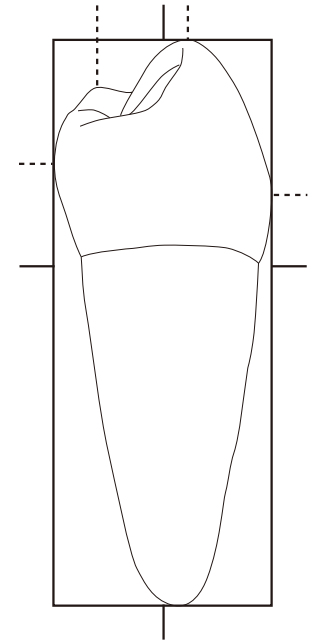
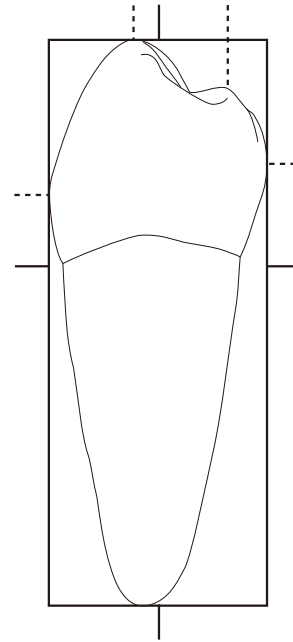
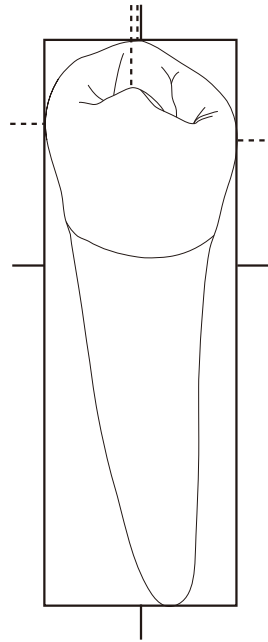
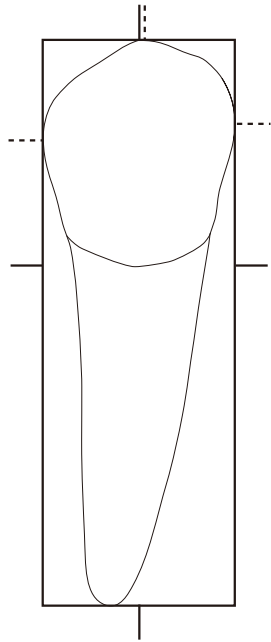

RIGHT 5

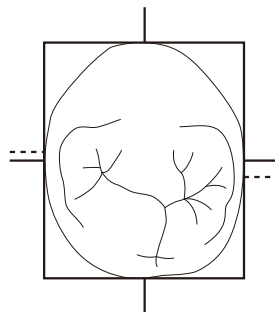
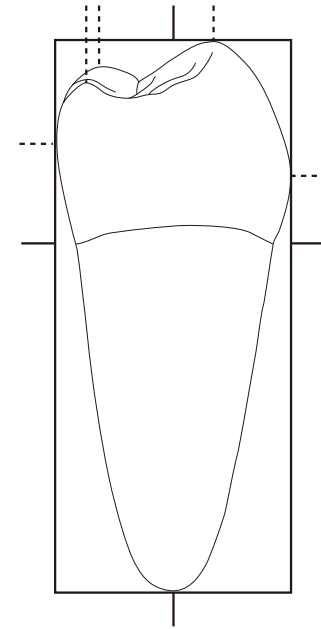
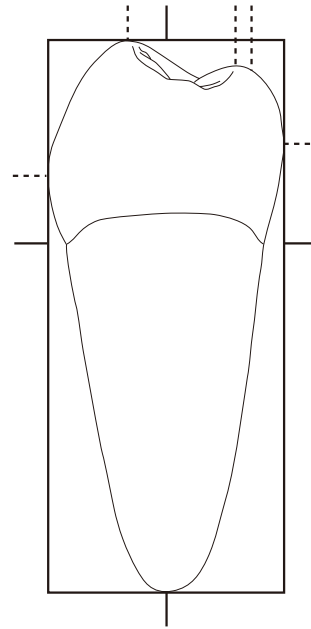
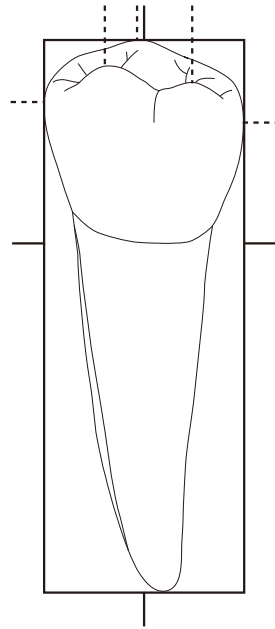
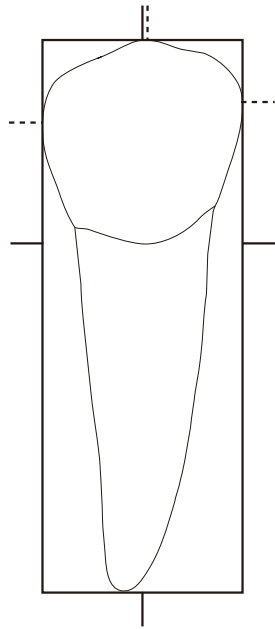

RIGHT 6

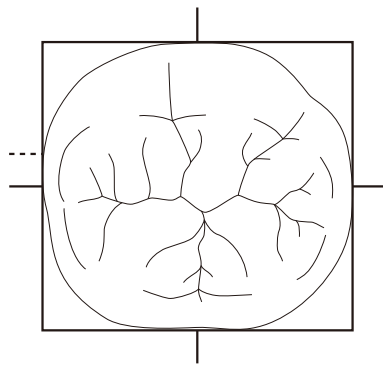
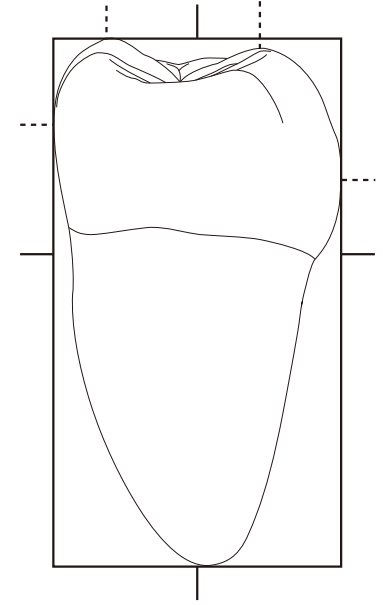
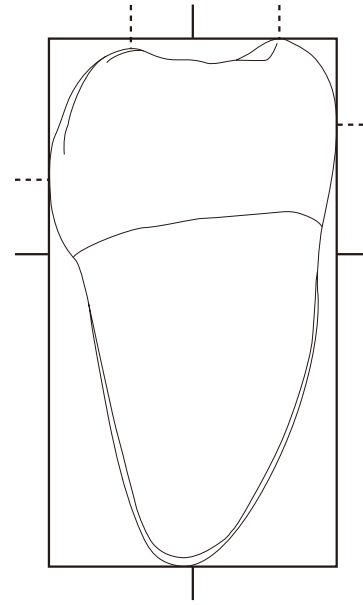
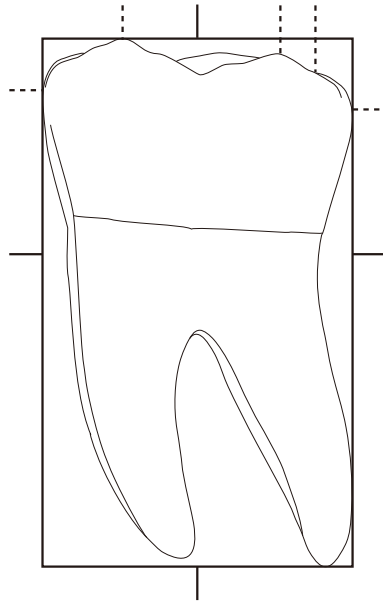
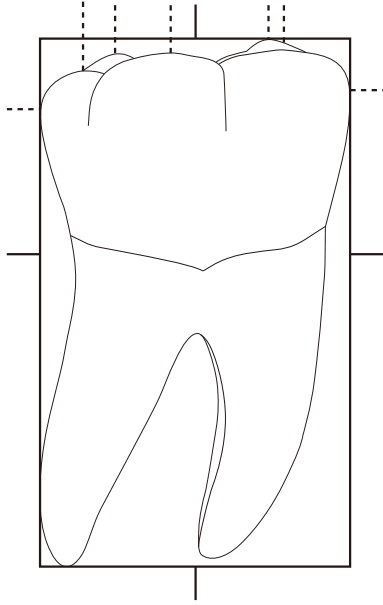

RIGHT 7

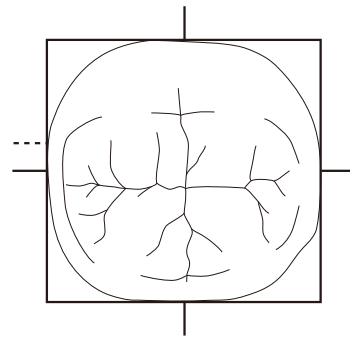
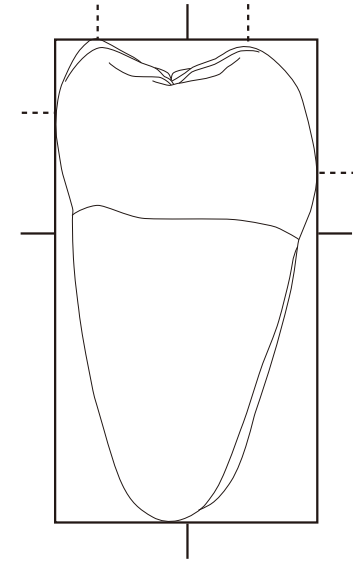
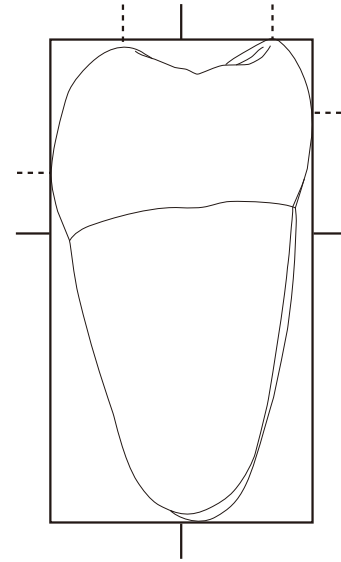
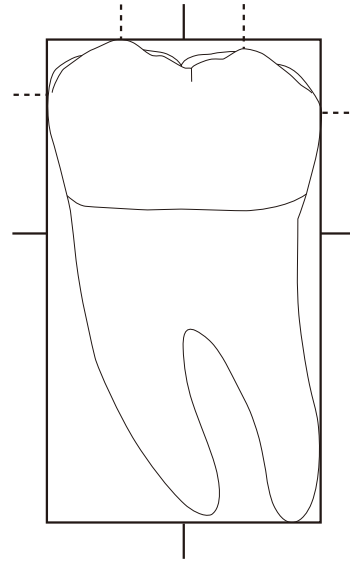
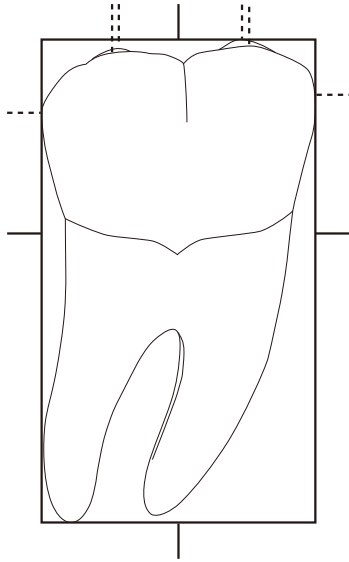

RIGHT 1

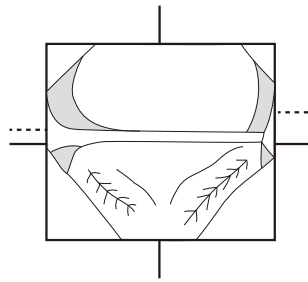
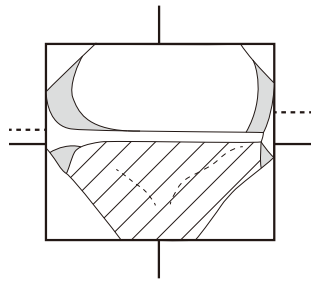
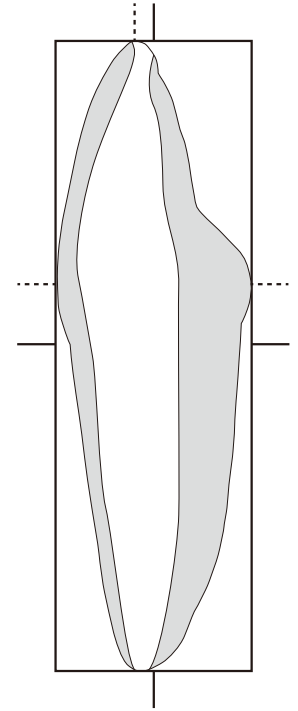
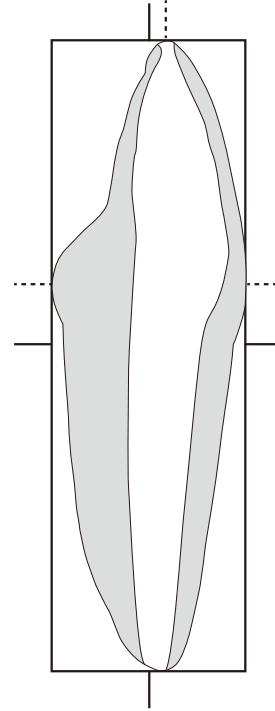
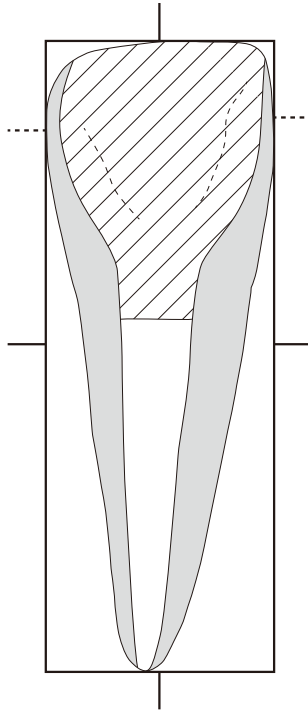
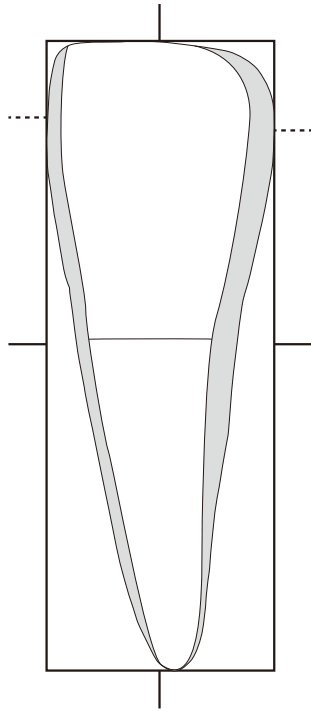

RIGHT 2

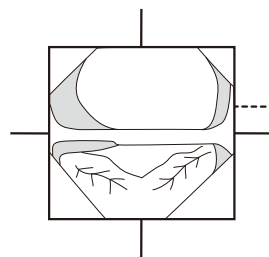
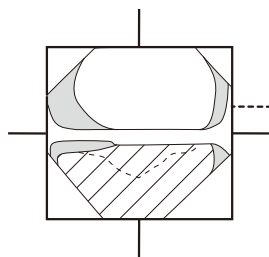
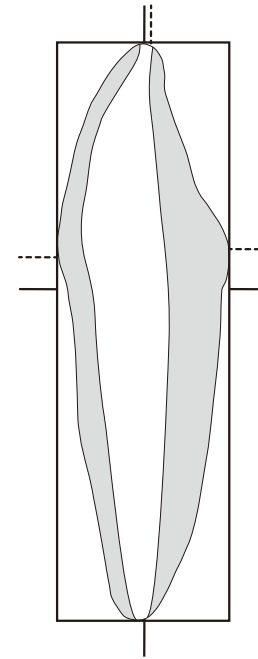
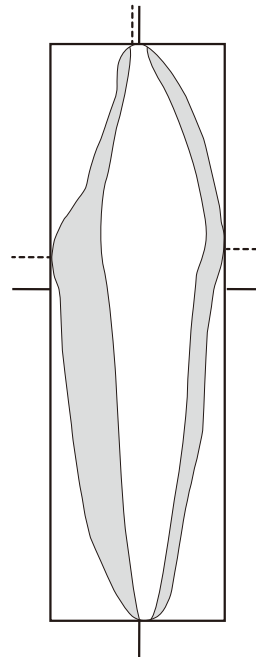
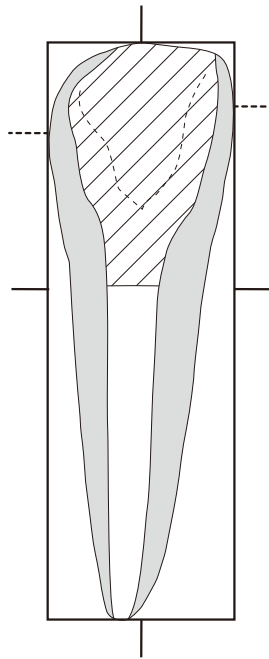
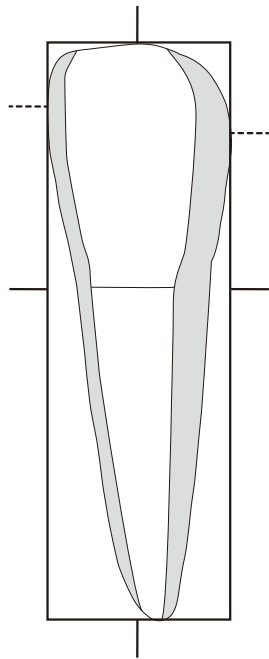

RIGHT 3

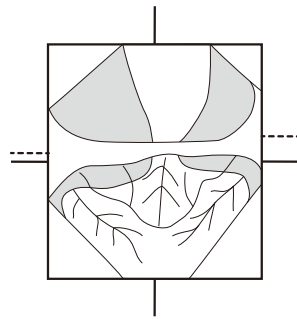
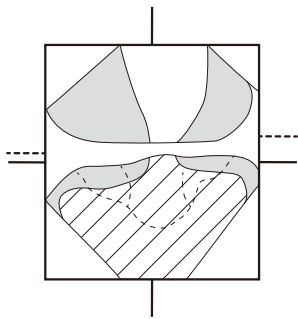
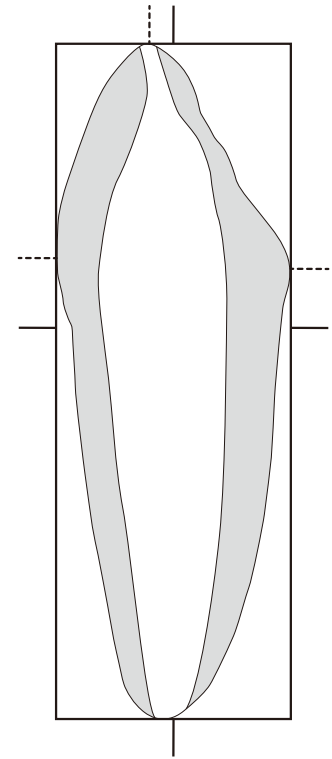
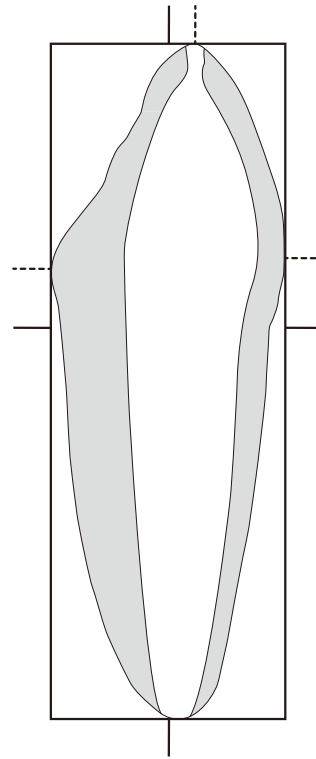
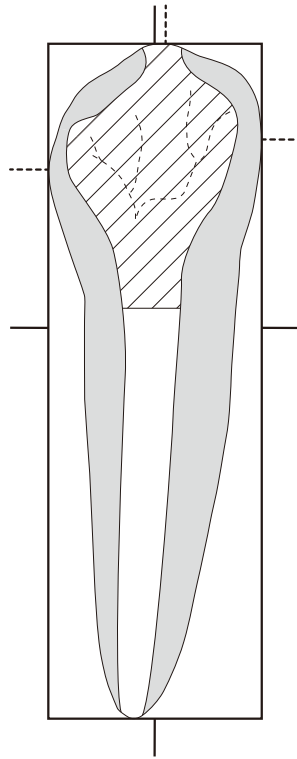
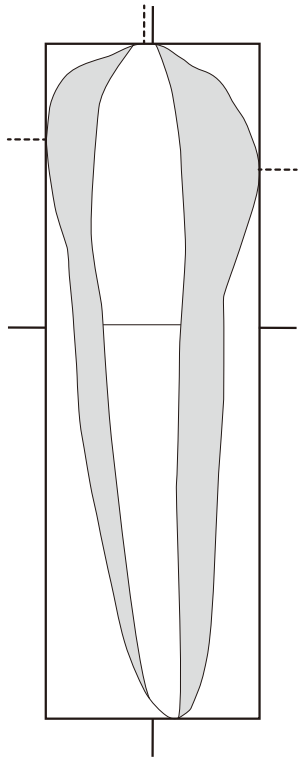

RIGHT 4

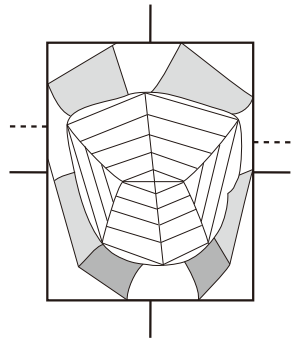
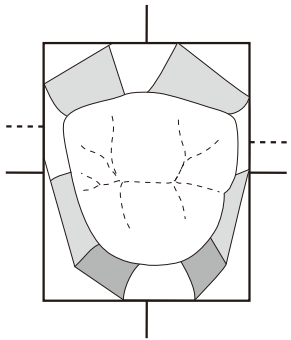
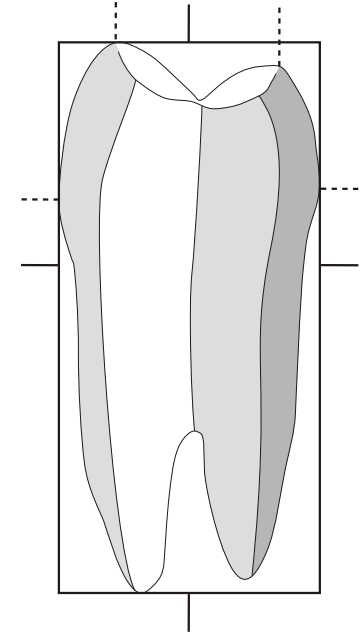
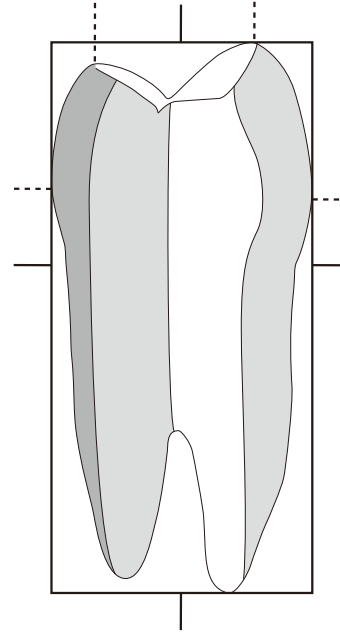
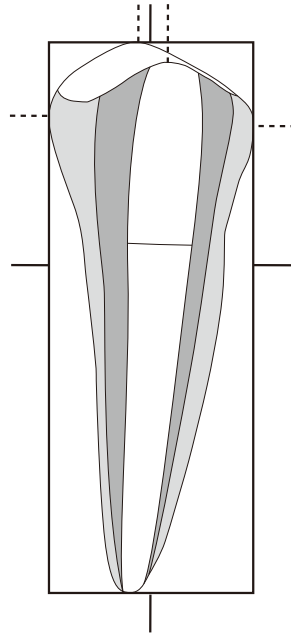
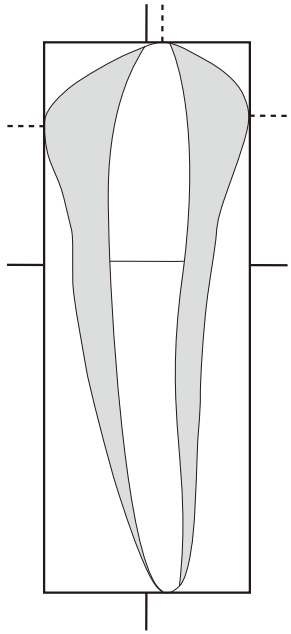

RIGHT 5

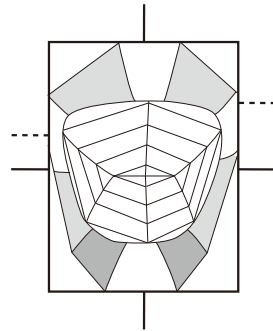
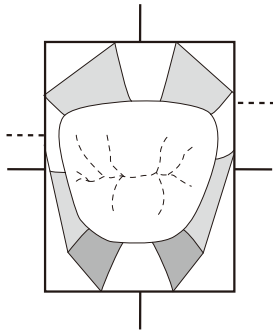
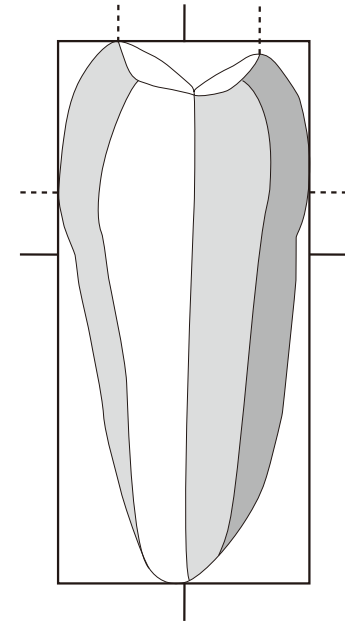
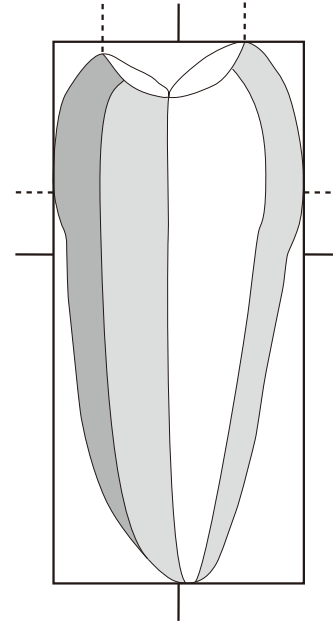
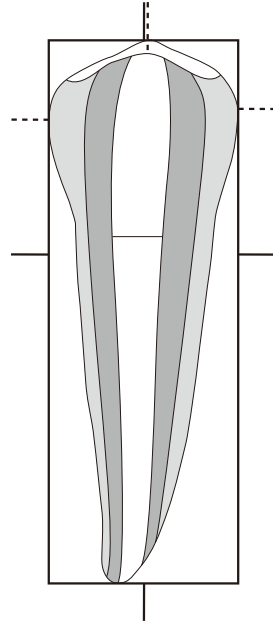
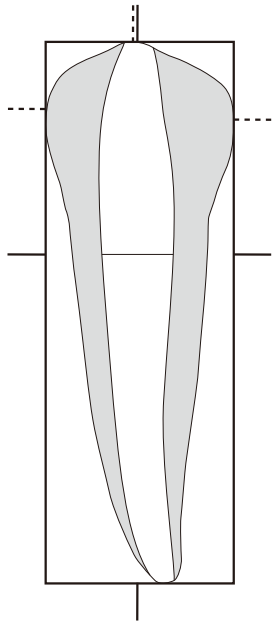

RIGHT 6

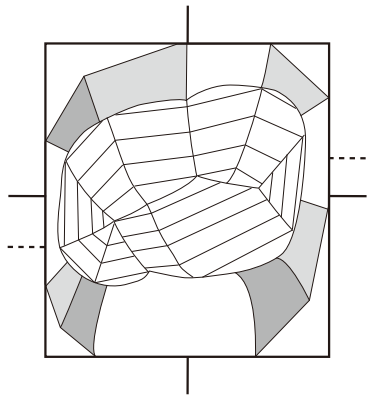
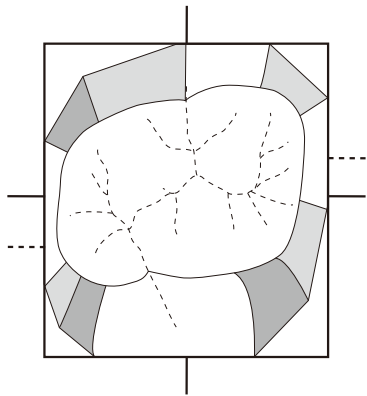
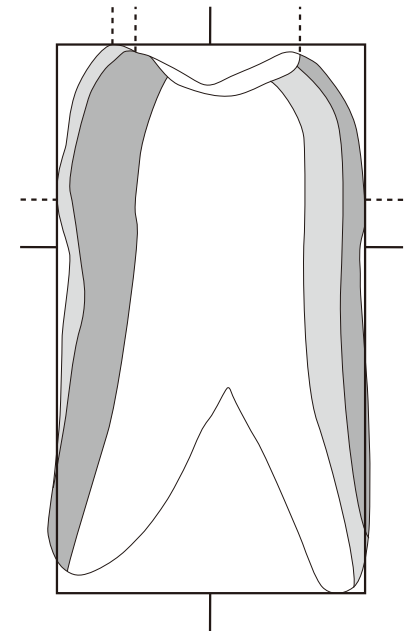
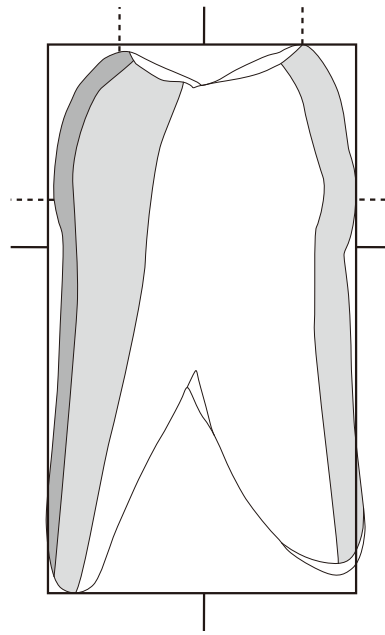
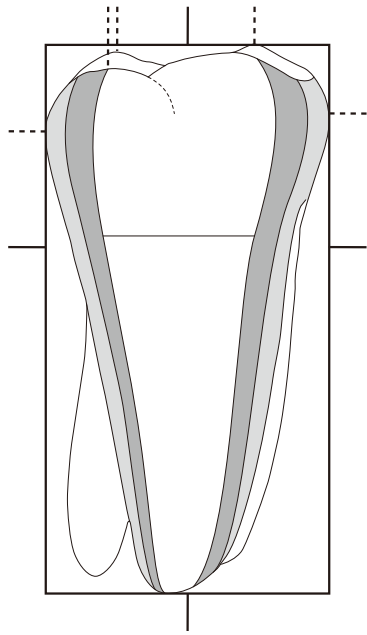
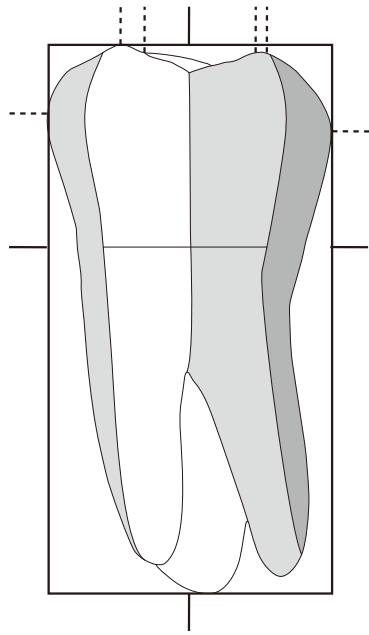

RIGHT 7

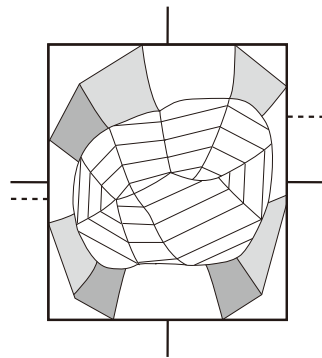
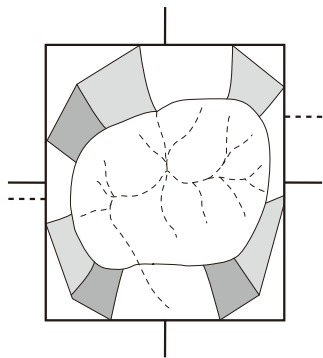
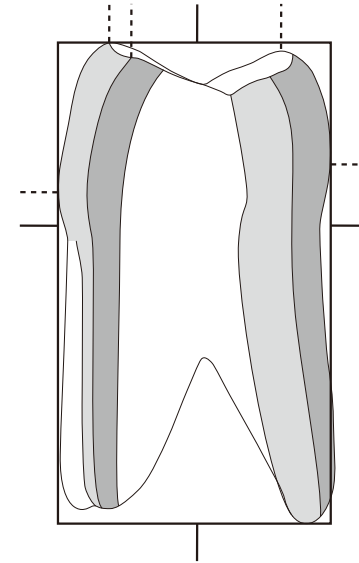
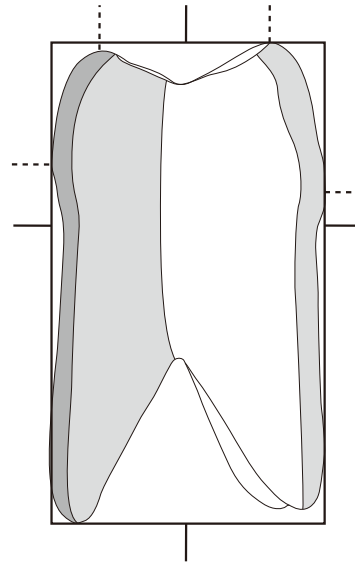
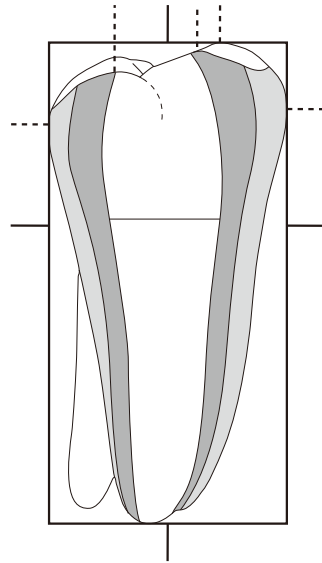
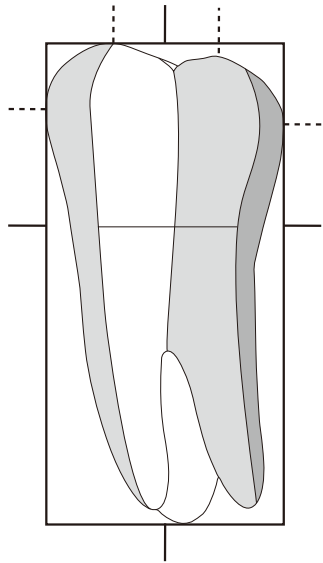

RIGHT 1

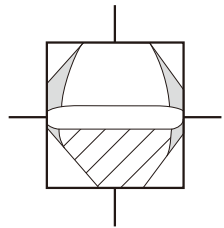
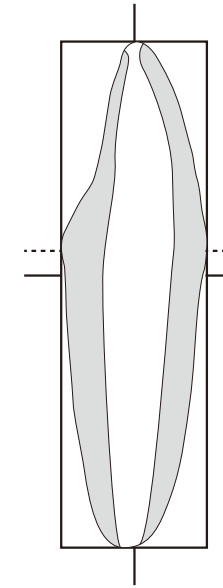
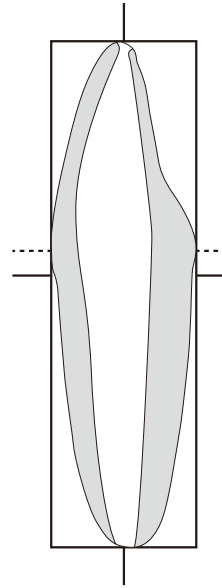
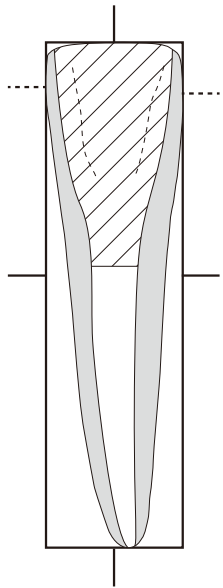
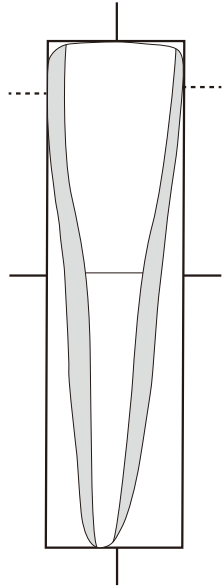

RIGHT 2

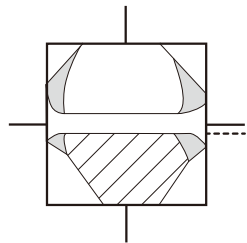
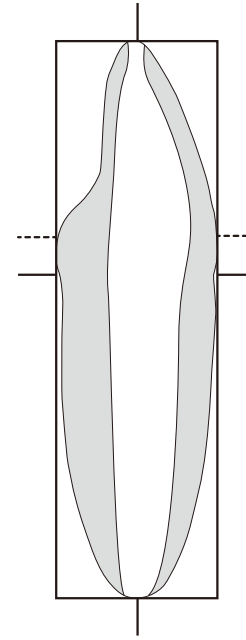
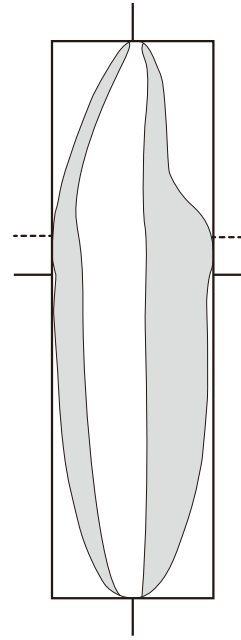
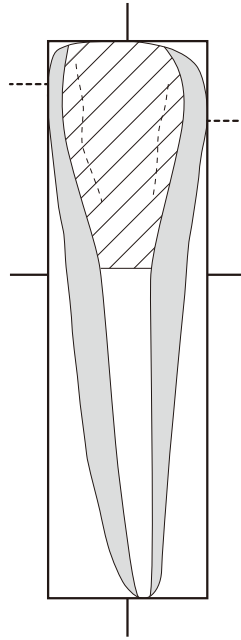
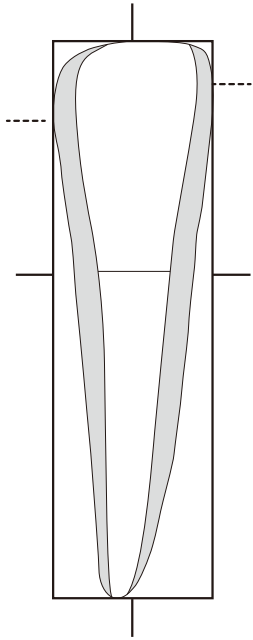

RIGHT 3

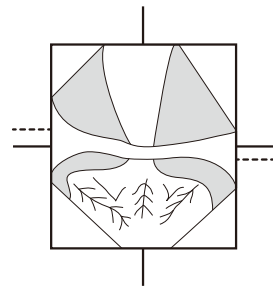
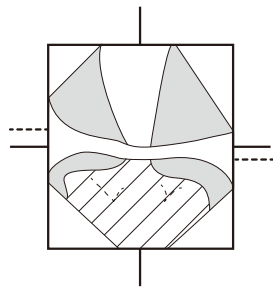
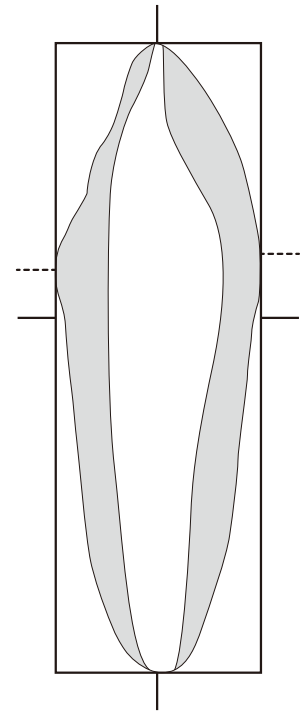
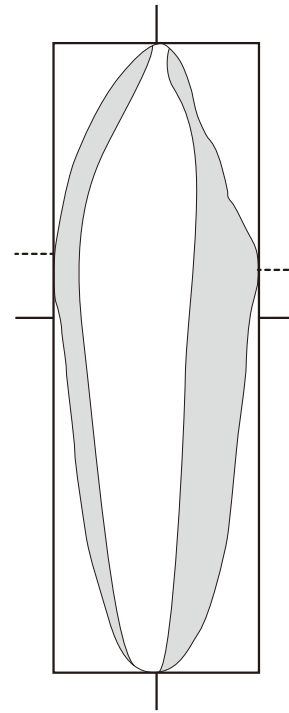
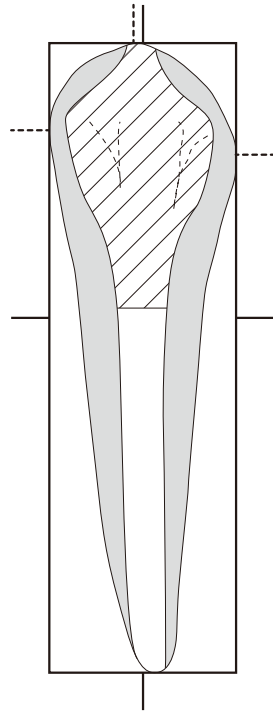
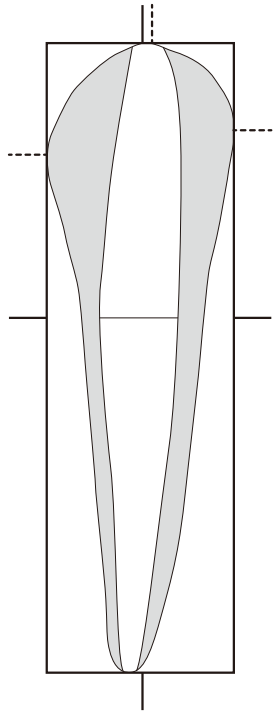

RIGHT 4

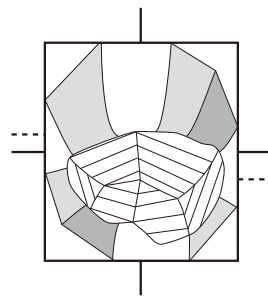
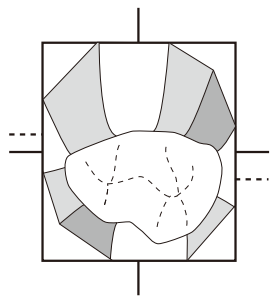
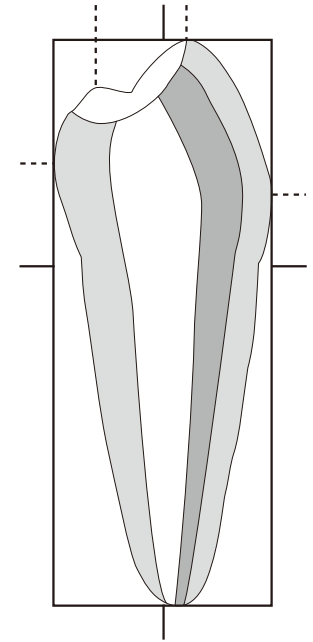
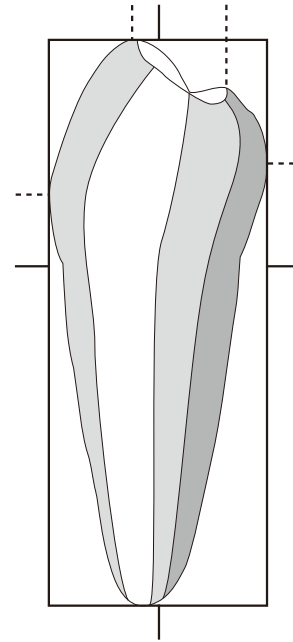
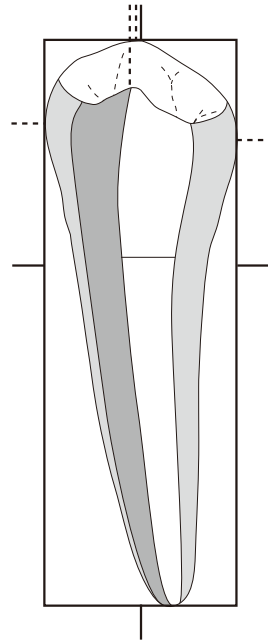
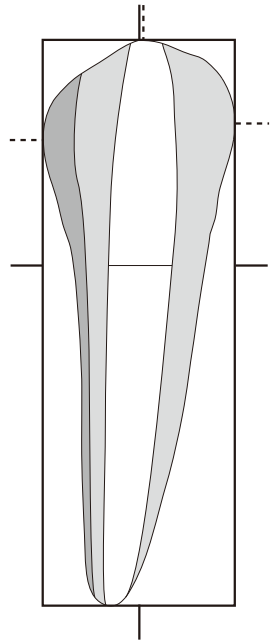

RIGHT 5

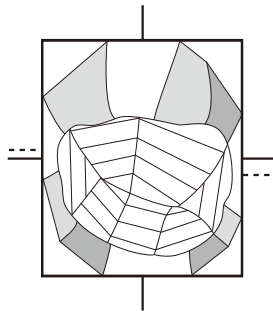
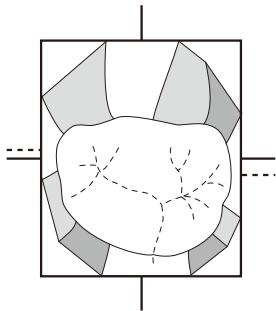
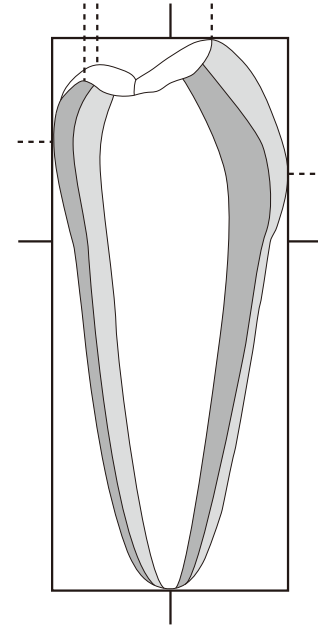
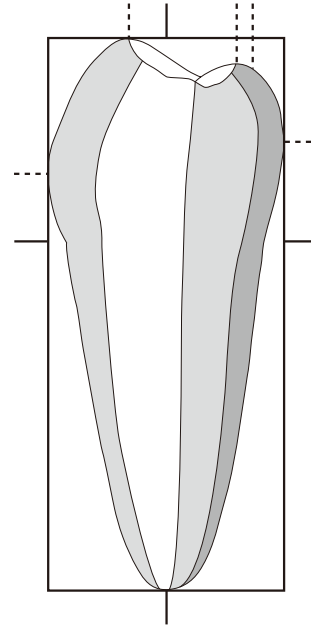
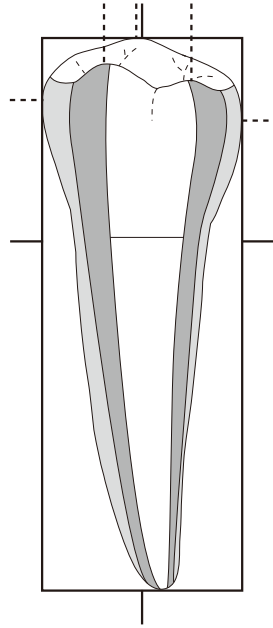
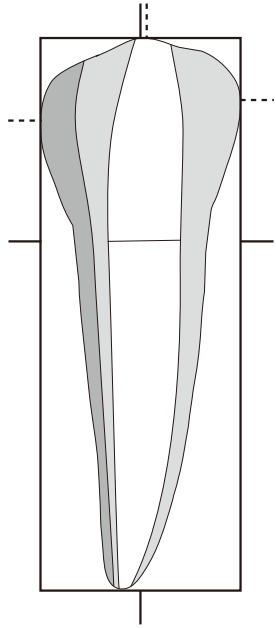

RIGHT 6

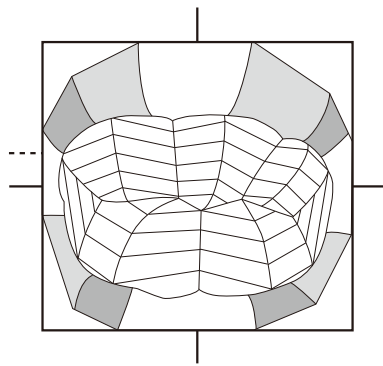
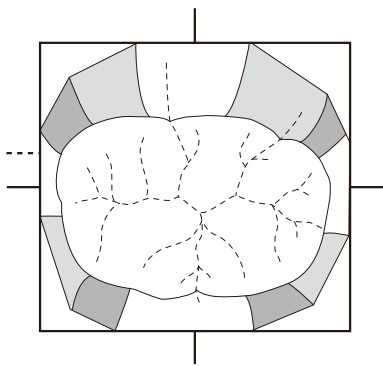
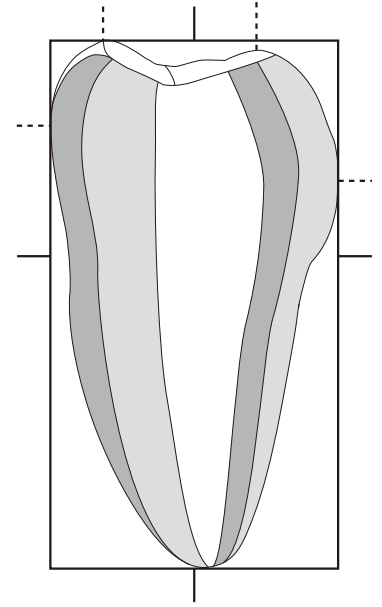
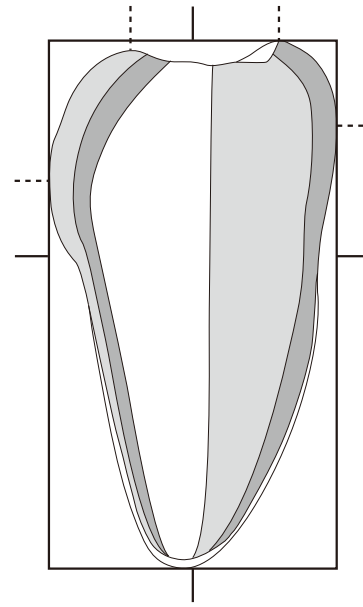
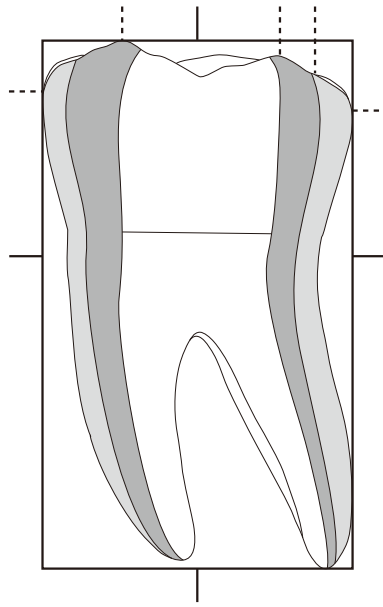
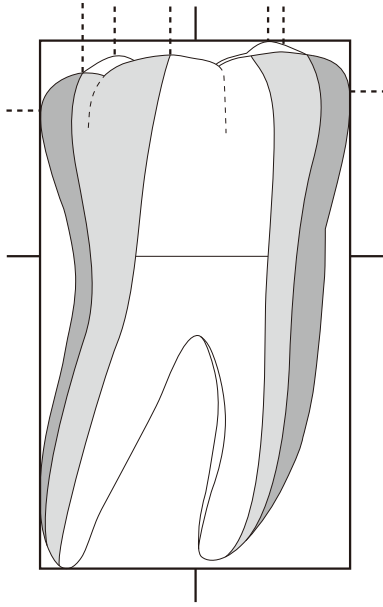

RIGHT 7

